



---

# 2021 PRODUCT GUIDE

---













- AZEK® Decking ..... 4
- AZEK® Porch ..... 7
- PRO™ Decking ..... 8
- EDGE™ Decking ..... 11
- Specialty Decking ..... 12
- Decking Accessories..... 13
- Decking Fasteners ..... 14
- Composite Railing..... 18
- Metal Railing ..... 28
- Composite ADA Railing ..... 34
- Metal ADA Railing ..... 35
- Railing Accessories..... 36
- Lighting ..... 37
- Pavers ..... 38
- DrySpace..... 39



- AZEK Trim .....42
- AZEK Moulding..... 48
- AZEK Siding ..... 52
- AZEK Board and Batten ..... 53
- AZEK Cladding..... 53
- AZEK Adhesive and Tools..... 54
- AZEK Cortex..... 56

## Decking Quick Comparison Chart

Easily compare Capped Composite and Capped Polymer decking options to best suit your performance, design, and budgetary needs.

	TimberTech EDGE			TimberTech PRO			TimberTech AZEK		
Collection	PRIME+™	PREMIER	TERRAIN®	RESERVE	LEGACY	HARVEST®	LANDMARK™	VINTAGE®	
<b>OVERALL QUALITY</b>	<b>GOOD</b>	<b>GOOD</b>	<b>BETTER</b>	<b>BEST</b>	<b>BEST</b>	<b>BETTER</b>	<b>BEST</b>	<b>PREMIUM</b>	
<b>Board Material</b>	Capped Composite	Capped Composite	Capped Composite	Capped Composite	Capped Composite	Capped Polymer	Capped Polymer	Capped Polymer	
<b>Limited Residential Warranty</b>	25 Years	25 Years	30 Years	30 Years	30 Years	Lifetime	Lifetime	Lifetime	
<b>Limited Commercial Warranty</b>	10 Years	10 Years	10 Years	10 Years	10 Years	20 Years	20 Years	20 Years	
<b>Fade &amp; Stain Warranty</b>	25 Years	25 Years	30 Years	30 Years	30 Years	50 Years	50 Years	50 Years	
<b>Profile &amp; Capping</b>	 3-Sided	 3-Sided	 4-Sided	 4-Sided	 4-Sided	 3-Sided	 4-Sided	 4-Sided	
<b>Moisture Resistance</b>	Good	Good	Better	Better	Better	<b>Best</b>	<b>Best</b>	<b>Best</b>	
<b>Grain Pattern</b>	Straight	Straight	Cathedral	Cathedral & Wire-Brushed	Hand-Scraped	Cathedral	Cathedral & Cross-cut	Wire-Brushed	
<b>Color Blending</b>	Blended	Solid	Solid or Blended	Blended	<b>Highly Blended</b>	Solid	Blended	<b>Highly Blended</b>	
<b>PRICE</b>	\$	\$	\$\$	\$\$\$	\$\$\$	\$\$	\$\$\$	\$\$\$\$	

## Common Decking Terms

### Color Blending

Subtle to bold streaking of lighter and darker colors to resemble premium hardwoods.

### Capping

Surface layer that protects against mold, mildew, moisture damage, scratches, fading, and staining.

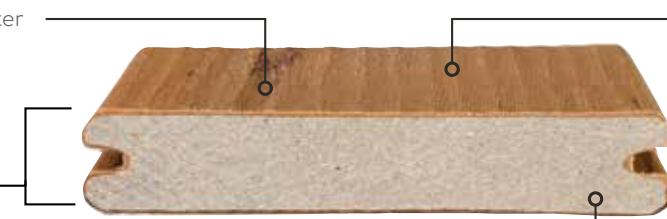

### Grain Pattern

The texture and finish on the board, representing a variety of wood species and treatments.

### Board Material

The material composition of the core, either Capped Composite or Capped Polymer.

**PRO TIP:** For second floor applications or where the bottom of the board is visible, choose a 4-sided capped collection for best aesthetics.



**TIMBERTECH® AZEK® DECKING**

Bring the advanced material technology in both the cap and core of TimberTech decking to your backyard. TimberTech AZEK Decking offers up to 40% better slip resistance than competitors' decking, stays cooler on sunny days, and has superior resistance to the elements. From premium performance to stylish sophistication, TimberTech decking is revolutionizing outdoor living with long-lasting, low-maintenance, and beautifully natural looking decking options.



Photo: Vintage Collection® Coastline®, Mahogany, and Dark Hickory

**Vintage Collection®**

**RICH. SOPHISTICATED. STYLISH.**



**Wildland Urban Interface Approved**  
8110-2042-0001  
SFM 12-7A-4A

Explore the "Designer Series" of decking to make every outdoor living space a masterpiece. This sophisticated collection features the most natural-looking colors with a subtle wire-brushed, low-gloss finish for a truly authentic wood look. This collection is rated a Class A on the Flame Spread Index.



PRODUCT DESCRIPTION	TimberTech Model Number		
	12'	16'	20'
<b>VINTAGE COLLECTION®</b>			
1 x 4 Square Shoulder Coastline	—	ADB13516CS	ADB13520CS
1 x 6 Square Shoulder Coastline	—	ADB15516CS	ADB15520CS
2 x 6 Square Shoulder Coastline MAX	ADB25512CS	ADB25516CS	ADB25520CS
1 x 6 Grooved Coastline	AGB15512CS	AGB15516CS	AGB15520CS
1 x 8 Square Shoulder Coastline	—	ADB172516CS	ADB172520CS
1 x 4 Square Shoulder English Walnut	—	ADB13516EW	ADB13520EW
1 x 6 Square Shoulder English Walnut	—	ADB15516EW	ADB15520EW
1 x 6 Grooved English Walnut	AGB15512EW	AGB15516EW	AGB15520EW
1 x 8 Square Shoulder English Walnut	—	ADB172516EW	ADB172520EW
1 x 4 Square Shoulder Weathered Teak	—	ADB13516WT	ADB13520WT
1 x 6 Square Shoulder Weathered Teak	—	ADB15516WT	ADB15520WT
1 x 6 Grooved Weathered Teak	AGB15512WT	AGB15516WT	AGB15520WT
1 x 8 Square Shoulder Weathered Teak	—	ADB172516WT	ADB172520WT
1 x 4 Square Shoulder Mahogany	—	ADB13516MH	ADB13520MH
1 x 6 Square Shoulder Mahogany	—	ADB15516MH	ADB15520MH
1 x 6 Grooved Mahogany	AGB15512MH	AGB15516MH	AGB15520MH
1 x 8 Square Shoulder Mahogany	—	ADB172516MH	ADB172520MH
1 x 4 Square Shoulder Dark Hickory	—	ADB13516DH	ADB13520DH
1 x 6 Square Shoulder Dark Hickory	—	ADB15516DH	ADB15520DH
1 x 6 Grooved Dark Hickory	AGB15512DH	AGB15516DH	AGB15520DH
1 x 8 Square Shoulder Dark Hickory	—	ADB172516DH	ADB172520DH
<b>VINTAGE FASCIA</b>			
12" Fascia Coastline	ADR5117512CS	—	—
12" Fascia English Walnut	ADR5117512EW	—	—
12" Fascia Weathered Teak	ADR5117512WT	—	—
12" Fascia Mahogany	ADR5117512MH	—	—
12" Fascia Dark Hickory	ADR5117512DH	—	—

**Multi-Width Decking**

**NARROW. STANDARD. WIDE.**

Standard width decking is not the standard any longer. Narrow and wide width decking is available in all Vintage Collection® colors. Additionally, the Harvest Collection® offers two wide width colors.

**MAX Decking**

**STRONG AND STURDY**

MAX capped polymer boards are 1.5" thick and span 24" on center, perfect for docks, boardwalks, and many commercial applications.

**Profile Options**

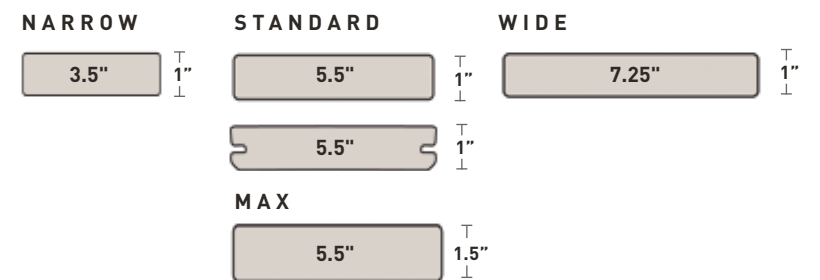



## Landmark Collection™

REFINED. RUSTIC. UNIQUE.

Deck out your outdoor living space with the modern wood tones from this collection. Based off of reclaimed lumber, the classic cathedral grain pattern is complemented by a rustic crosscut grain and matte finish. The color-blending in these decking boards has cascading hues which result in natural color variation. And, just like in nature, the highlights and lowlights in each board's color vary from end-to-end and board-to-board making each deck unique.



CASTLE GATE™ AMERICAN WALNUT™

## Harvest Collection®

WARM. NATURAL. EFFORTLESS.

This stylish collection offers solid color boards for a painted wood look. Composed of soft, natural shades, this collection complements most home's exteriors and offers a traditional cathedral wood grain pattern.



BROWNSTONE SLATE GRAY KONA®

PRODUCT DESCRIPTION	TimberTech Model Number		
	12'	16'	20'
<b>LANDMARK COLLECTION™</b>			
1 x 6 Square Shoulder Castle Gate™	—	ADB15516CG	ADB15520CG
1 x 6 Grooved Castle Gate™	AGB15512CG	AGB15516CG	AGB15520CG
1 x 6 Square Shoulder American Walnut™	—	ADB15516AW	ADB15520AW
1 x 6 Grooved American Walnut™	AGB15512AW	AGB15516AW	AGB15520AW
<b>LANDMARK FASCIA</b>			
12" Fascia Castle Gate™	ADR5117512CG	—	—
12" Fascia American Walnut™	ADR5117512AW	—	—

### Profile Options

#### STANDARD

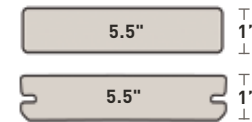

PRODUCT DESCRIPTION	TimberTech Model Number		
	12'	16'	20'
<b>HARVEST COLLECTION®</b>			
1 x 6 Square Shoulder Brownstone	ADCB15512BS	ADCB15516BS	ADCB15520BS
1 x 6 Grooved Brownstone	AGB15512BS	AGB15516BS	AGB15520BS
1 x 8 Square Shoulder Brownstone	—	ADCB172516BS	ADCB172520BS
1 x 6 Square Shoulder Slate Gray	ADCB15512SG	ADCB15516SG	ADCB15520SG
1 x 6 Grooved Slate Gray	AGB15512SG	AGB15516SG	AGB15520SG
1 x 8 Square Shoulder Slate Gray	—	ADCB172516SG	ADCB172520SG
2 x 6 Square Shoulder Slate Gray MAX	ADCB25512SG	ADCB25516SG	ADCB25520SG
1 x 6 Square Shoulder Kona®	—	ADB15516KOAAT	ADB15520KOAAT
<b>HARVEST FASCIA</b>			
12" Fascia Brownstone	ADCR5117512BS	—	—
12" Fascia Slate Gray	ADCR5117512SG	—	—
12" Fascia Kona®	ADR5117512KOAAT	—	—

### Profile Options

#### STANDARD

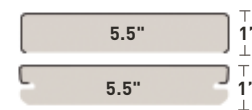

#### WIDE

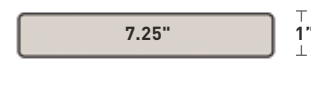

#### MAX

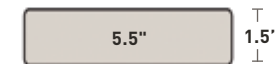

Photo: Slate Gray Porch

## Porch

ELEGANT. STYLISH. DURABLE.

Forget curb appeal — it's all about porch appeal these days. Warm, natural-looking, and nuanced colors round out the Porch Collection to help create an inviting space to greet guests or simply lounge. With tongue and groove technology, these porch boards feature a tighter-fit between boards for a more polished look. Offered in both standard and wide width, you can make a style statement on your front porch.



PRODUCT DESCRIPTION	TimberTech Model Number		
	10'	12'	16'
<b>AZEK PORCH</b>			
1 x 4 T&G Porch Slate Gray	ADCP13510SG	ADCP13512SG	ADCP13516SG
1 x 4 T&G Porch Oyster	—	ADP13512OR	ADP13516OR
1 x 6 T&G Porch Mahogany	—	ADP15512MH	ADP15516MH
1 x 4 T&G Porch Mahogany	—	ADP13512MH	ADP13516MH
1 x 6 T&G Porch Dark Hickory	—	ADP15512DH	ADP15516DH
1 x 4 T&G Porch Dark Hickory	—	ADP13512DH	ADP13516DH
1 x 6 T&G Porch Coastline	—	ADP15512CS	ADP15516CS
1 x 4 T&G Porch Coastline	—	ADP13512CS	ADP13516CS
1 x 6 T&G Porch Weathered Teak	—	ADP15512WT	ADP15516WT
1 x 4 T&G Porch Weathered Teak	—	ADP13512WT	ADP13516WT

\*Extended lead times may apply to certain geographies.

### Profile Options

#### STANDARD



#### WIDE





TIMBERTECH® PRO® DECKING

Explore premium decking in bold, beautiful colors with exceptional cap protection. Boards in these collections are covered from top to bottom and in the grooves with advanced Mold Guard® Technology to prevent moisture damage. Composed of up to 80% recycled material and offering color options ranging from solid to infinitely variable, the TimberTech PRO decking line doesn't disappoint.



PHOTO: Legacy Collection Pecan



Legacy Collection

BOLD. DRAMATIC. UNIQUE.

Stand apart from run-of-the-mill decks with this stunning, artisanal collection. This decking features a complex blend of several colors, natural board-to-board color variation, and a hand-scraped texture that offers old world charm. Just as every tree found in nature is unique, every deck board in the Legacy Collection is unique.

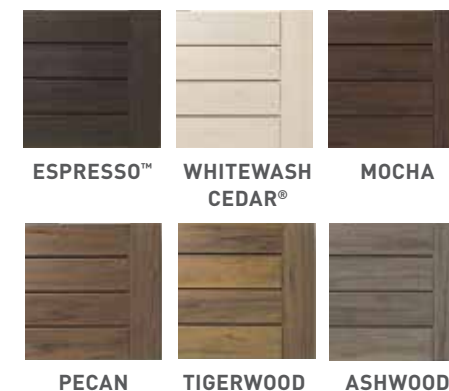

PRODUCT DESCRIPTION	TimberTech Model Number		
	12'	16'	20'
<b>LEGACY COLLECTION</b>			
1 x 6 Grooved Espresso	LCGV5412E	LCGV5416E	LCGV5420E
1 x 6 Square Shoulder Espresso	—	LC5416E	LC5420E
1 x 6 Grooved Whitewash Cedar	LCGV5412WC	LCGV5416WC	LCGV5420WC
1 x 6 Square Shoulder Whitewash Cedar	—	LC5416WC	LC5420WC
1 x 6 Grooved Mocha	LCGV5412M	LCGV5416M	LCGV5420M
1 x 6 Square Shoulder Mocha	—	LC5416M	LC5420M
1 x 6 Grooved Pecan	LCGV5412P	LCGV5416P	LCGV5420P
1 x 6 Square Shoulder Pecan	—	LC5416P	LC5420P
1 x 6 Grooved Tigerwood	LCGV5412TW	LCGV5416TW	LCGV5420TW
1 x 6 Square Shoulder Tigerwood	—	LC5416TW	LC5420TW
1 x 6 Grooved Ashwood	LCGV5412AW	LCGV5416AW	LCGV5420AW
1 x 6 Square Shoulder Ashwood	—	LC5416AW	LC5420AW
<b>LEGACY FASCIA</b>			
12" Fascia Espresso	FBLC12E	—	—
12" Fascia Whitewash Cedar	FBLC12WC	—	—
12" Fascia Mocha	FBLC12M	—	—
12" Fascia Pecan	FBLC12P	—	—
12" Fascia Tigerwood	FBLC12TW	—	—
12" Fascia Ashwood	FBLC12AW	—	—
<b>LEGACY RISER</b>			
7-1/2" Riser Espresso	LCRISERE	—	—
7-1/2" Riser Whitewash Cedar	LCRISERWC	—	—
7-1/2" Riser Mocha	LCRISERM	—	—
7-1/2" Riser Pecan	LCRISERP	—	—
7-1/2" Riser Tigerwood	LCRISERTW	—	—
7-1/2" Riser Ashwood	LCRISERAW	—	—

Profile Options

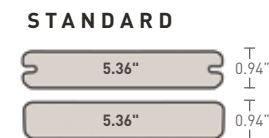

Reserve Collection

AUTHENTIC. RECLAIMED. INSPIRING.

Turn up the volume on composite decking with the complex coloring and striking wood grain visual from the colors of the Reserve Collection. Inspired by reclaimed wood, the heavy wire-brush finish highlights the classic cathedral wood grain and offers better slip resistance than competitors.

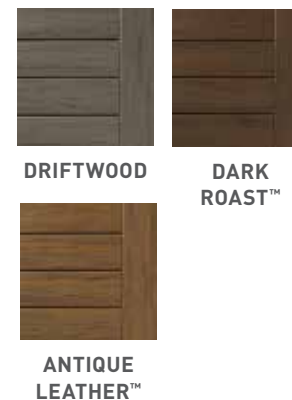

PRODUCT DESCRIPTION	TimberTech Model Number		
	12'	16'	20'
<b>RESERVE COLLECTION</b>			
1 x 6 Grooved Driftwood	RCGV5412DW	RCGV5416DW	RCGV5420DW
1 x 6 Square Shoulder Driftwood	—	RC5416DW	RC5420DW
1 x 6 Grooved Antique Leather	RCGV5412AL	RCGV5416AL	RCGV5420AL
1 x 6 Square Shoulder Antique Leather	—	RC5416AL	RC5420AL
1 x 6 Grooved Dark Roast	RCGV5412DR	RCGV5416DR	RCGV5420DR
1 x 6 Square Shoulder Dark Roast	—	RC5416DR	RC5420DR
<b>RESERVE FASCIA</b>			
12" Fascia Driftwood	FBRC12DW	—	—
12" Fascia Antique Leather	FBRC12AL	—	—
12" Fascia Dark Roast	FBRC12DR	—	—
<b>RESERVE RISER</b>			
7-1/2" Riser Driftwood	RCRISERDW	—	—
7-1/2" Riser Antique Leather	RCRISERAL	—	—
7-1/2" Riser Dark Roast	RCRISERDR	—	—

Profile Options

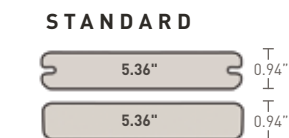



## Terrain Collection®

TRADITIONAL. TIMELESS. RUGGED.

Tap into traditional and timeless hues for your outdoor oasis. Ranging from solid to minimally blended colors, these scalloped boards offer a complex, rugged wood grain pattern designed to camouflage wear and tear from everyday life. This practical collection is the perfect combination of value and performance.

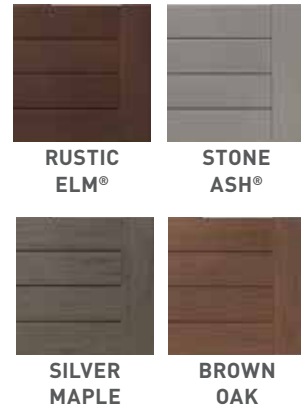

PRODUCT DESCRIPTION	TimberTech Model Number		
	12'	16'	20'
<b>TERRAIN COLLECTION™</b>			
1 x 6 Grooved Brown Oak	TCGV5412BO	TCGV5416BO	TCGV5420BO
1 x 6 Square Shoulder Brown Oak	—	TC5416BO	TC5420BO
1 x 6 Grooved Silver Maple	TCGV5412SM	TCGV5416SM	TCGV5420SM
1 x 6 Square Shoulder Silver Maple	—	TC5416SM	TC5420SM
1 x 6 Grooved Rustic Elm	TCGV5412RE	TCGV5416RE	TCGV5420RE
1 x 6 Square Shoulder Rustic Elm	—	TC5416RE	TC5420RE
1 x 6 Grooved Stone Ash	TCGV5412SA	TCGV5416SA	TCGV5420SA
1 x 6 Square Shoulder Stone Ash	—	TC5416SA	TC5420SA
<b>TERRAIN FASCIA</b>			
12" Fascia Brown Oak	FBTC12BO	—	—
12" Fascia Silver Maple	FBTC12SM	—	—
12" Fascia Rustic Elm	FBTC12RE	—	—
12" Fascia Stone Ash	FBTC12SA	—	—
<b>TERRAIN RISER</b>			
7-1/4" Riser Brown Oak	TCRISERBO	—	—
7-1/4" Riser Silver Maple	TCRISERSM	—	—
7-1/4" Riser Rustic Elm	TCRISERRE	—	—
7-1/4" Riser Stone Ash	TCRISERSA	—	—

### Profile Options

#### STANDARD

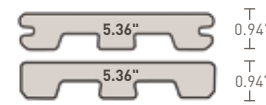

## Premier Collection

ALLURING. CLASSIC. SENSIBLE.

Design your ideal deck with the beautiful colors in this inspired decking collection. These full profile boards offer monochromatic colors for a painted wood visual and feature a subtle, straight wood grain pattern. Give your homeowners the long-lasting look that they've been craving with the Premier Collection.

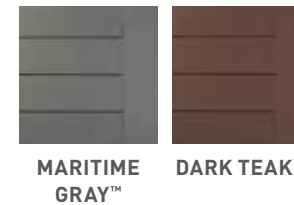

PRODUCT DESCRIPTION	TimberTech Model Number		
	12'	16'	20'
<b>PREMIER COLLECTION</b>			
1 x 6 Grooved Dark Teak	EFGV5412DT	EFGV5416DT	EFGV5420DT
1 x 6 Square Shoulder Dark Teak	—	EF5416DT	EF5420DT
1 x 6 Grooved Maritime Gray	EFGV5412MG	EFGV5416MG	EFGV5420MG
1 x 6 Square Shoulder Maritime Gray	—	EF5416MG	EF5420MG
<b>PREMIER FASCIA</b>			
12" Fascia Dark Teak	FBE12DT	—	—
12" Fascia Maritime Gray	FBE12MG	—	—
<b>PREMIER RISER</b>			
7-1/4" Riser Dark Teak	ERISERDT	—	—
7-1/4" Riser Maritime Gray	ERISERMG	—	—

### Profile Options

#### STANDARD



## Prime+ Collection®

EYE-CATCHING. VIBRANT. ATTAINABLE.

Lean in to beautifully simple colors with this inspired decking collection. The moderately varied hues and subtle, straight grain pattern create an authentic wood visual. Get the look everyone is ditching wood for and choose the Prime+ Collection's scalloped boards.

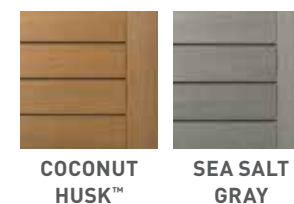

PRODUCT DESCRIPTION	TimberTech Model Number		
	12'	16'	20'
<b>PRIME+ COLLECTION</b>			
1 x 6 Grooved Coconut Husk	PRGV5412CH	PRGV5416CH	PRGV5420CH
1 x 6 Square Shoulder Coconut Husk	—	PR5416CH	PR5420CH
1 x 6 Grooved Sea Salt Gray	PRGV5412ST	PRGV5416ST	PRGV5420ST
1 x 6 Square Shoulder Sea Salt Gray	—	PR5416ST	PR5420ST
<b>PRIME+ FASCIA</b>			
12" Fascia Coconut Husk	FBE12CH	—	—
12" Fascia Sea Salt Gray	FBE12ST	—	—
<b>PRIME+ RISER</b>			
7-1/4" Riser Coconut Husk	ERISERCH	—	—
7-1/4" Riser Sea Salt Gray	ERISERST	—	—

### Profile Options

#### STANDARD



**TIMBERTECH® EDGE™ DECKING**

Go Against the Grain® and step up into the world of long-lasting, low-maintenance, capped composite decking. This attainable composite decking line allows homeowners to ditch the costly and laborious maintenance that comes with traditional wood for good! Plus, it's composed of up to 80% recycled materials, making it the sustainable option.

LIMITED

25 YEAR WARRANTY

FADE & STAIN LIMITED

25 YEAR WARRANTY

TIMBERTECH

CAPPED COMPOSITE DECKING

Photo: Sea Salt Gray with Classic Composite Series Railing



Photo: Terrain Collection® Rustic Elm



**TIMBERTECH® SPECIALTY DECKING**

Known for long-term durability and low-maintenance nature, the specialty boards combine the look and feel of natural wood at a price that's just a step above traditional lumber. Each board features a slip-resistant, splinter-free wood grain texture. Plus, the 4-sided protective shell provides additional protection from the elements.

Photo: ReliaBoard Cedar



8110-2042:0003  
SFM 12-7A-4A

**ReliaBoard®**

A step up from traditional lumber, ReliaBoard demands attention for all the right reasons. Boasting a classic cathedral wood grain pattern and the look of painted wood, this decking is a practical and affordable option for homeowners looking to ditch the costly maintenance of traditional wood decking. These beautiful boards are covered by a 4-sided, protective and low-maintenance shell.

PRODUCT DESCRIPTION	TimberTech Model Number		
	12'	16'	20'
<b>RELIABOARD</b>			
1 x 6 Square Shoulder Cedar	RB5412C	RB5416C	RB5420C
1 x 6 Square Shoulder Gray	RB5412G	RB5416G	RB5420G
<b>FASCIA</b>			
12" TwinFascia Board Cedar	FBVG12C	—	—
12" TwinFascia Board Gray	FBVG12G	—	—
<b>RISER</b>			
7-1/4" TwinRiser Board Cedar	FBRISERC	—	—
7-1/4" TwinRiser Board Gray	FBRISERG	—	—

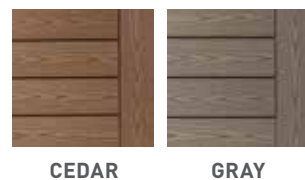

**Profile Options**

**STANDARD**



- BLACK
- CEDAR
- GRAY
- TEAK
- WALNUT

**End Coating**

- Enhance decking end cuts with a rich, gorgeous finish that delivers superior durability and performance
- One 8 oz. bottle covers approximately 250 TimberTech end cuts
- Apply with a brush or roller

PRODUCT DESCRIPTION	TimberTech Model Number
<b>END COATING COLORS</b>	
Black	ECOATB
Cedar	ECOATC
Gray	ECOATG
Teak	ECOATT
Walnut	ECOATW



**PRO-Tac™ Flashing and Joist Tape**

- A heavy duty, flexible, all weather tape to extend the life of decking substructures
- The butyl adhesive provides an advanced, secure bond to joists that won't peel off
- Can be used in all weather conditions; rated for use in temperatures from -70°F to 200°F

PRODUCT DESCRIPTION	TimberTech Model Number	
	25'	65'
<b>PRO-TAC TAPE</b>		
1.625" Pro-Tac Joist Tape	—	PTCS1625X65B
2.5" Pro-Tac Joist Tape	—	PTCS25X65B
3.25" Pro-Tac Joist Tape	—	PTCS325X65B
4" Pro-Tac Joist Tape	—	PTCS4X65B
12" Pro-Tac Joist Tape	PTCS12X25B	—



Non-toxic, bleach-free, and biodegradable

**TimberTech DeckCleaner™**

- Cleans decking, railing, trim, and moulding
- Concentrated formula that removes dirt, mold, mildew, dust, pollen, and more
- Cleans approximately 1,000 square feet of surface area when properly diluted
- Guaranteed not to damage TimberTech products, or affect the warranty, when used as directed on the recommended products
- Not intended for wood or traditional composite decking (non-capped)

PRODUCT DESCRIPTION	TimberTech Model Number
<b>TIMBERTECH DECKCLEANER</b>	
1 Gallon DeckCleaner (case of 4)	TTCLNCASE1G

	AZEK® Deck & Porch Collections			PRO™ Deck Collections			EDGE™ Deck Collections		Specialty Deck Collections	TimberTech Products			
	Vintage	Landmark	Harvest	Legacy	Reserve	Terrain	Premier	Prime+	Reliaboar®	Capped Composite Rail	Aluminum Rail	DrySpace	Pavers
TimberTech DeckCleaner	•	•	•	•	•	•	•	•		•	•	•	•
Stiff Natural Fiber Deck Scrub Brush	•	•	•										•
Medium Stiffness Nylon Bristle Deck Scrub Brush				•	•	•	•	•	•				
Terry Cloth										•	•	•	

**TIMBERTECH® FASTENERS**

Opt for the best fastening systems to install your deck. These high-quality fasteners give decks added strength and integrity for years to come.



Photo: TOPLoc® for AZEK® Color-matched stainless steel decking fasteners on Mahogany decking

**TOPLoc® for AZEK®**

Color-matched, stainless steel decking fasteners.

FOR USE WITH ALL TIMBERTECH AZEK® DECK BOARDS



- Head painted to complement AZEK Decking colors
- 305 grade stainless steel screws ACQ approved, with a TORX® ttap® drive system for a wobble-free installation
- Compatible with all TimberTech AZEK deck boards

PRODUCT DESCRIPTION	TimberTech Model Number	
	100 SQ FT	300 SQ FT
<b>TOPLOC FOR TIMBERTECH AZEK</b>		
2½" TOPLoc Screws Brown	ATLOC100B	ATLOC300B
2½" TOPLoc Screws Dark Brown	ATLOC100DB	ATLOC300DB
2½" TOPLoc Screws Light Tan	ATLOC100LT	ATLOC300LT
2½" TOPLoc Screws Light Gray	ATLOC100LG	ATLOC300LG
2½" TOPLoc Screws Dark Gray	ATLOC100DG	ATLOC300DG

**TOPLoc® Fascia for AZEK®**

Color-matched stainless steel fastener designed for fascia boards.

FOR USE WITH ALL AZEK® COLLECTIONS FASCIA BOARDS



- Head painted to complement AZEK Fascia colors
- 305 grade stainless steel screws ACQ approved, with a TORX® ttap® drive system for a wobble-free installation
- Compatible with fascia boards from the TimberTech AZEK line

PRODUCT DESCRIPTION	TimberTech Model Number	
	30 LIN FT	
<b>TOPLOC FASCIA FOR AZEK</b>		
1⅝" TOPLoc Fascia Screws Brown 100/Pkg	ATLOCFAS30B	
1⅝" TOPLoc Fascia Screws Dark Brown 100/Pkg	ATLOCFAS30DB	
1⅝" TOPLoc Fascia Screws Light Tan 100/Pkg	ATLOCFAS30LT	
1⅝" TOPLoc Fascia Screws Light Gray 100/Pkg	ATLOCFAS30LG	
1⅝" TOPLoc Fascia Screws Dark Gray 100/Pkg	ATLOCFAS30DG	

**Colors:**  
TOPLoc for TimberTech AZEK Decking & Fascia

**Brown:** Mahogany  
**Dark Brown:** Kona®, Dark Hickory, English Walnut™, American Walnut™

**Light Tan:** Weathered Teak™, Brownstone  
**Light Gray:** Slate Gray, Coastline®  
**Dark Gray:** Castle Gate™

**TOPLoc® for PRO® & EDGE™**

Top-down, color-matched, carbon steel or stainless steel deck fasteners.

USE WITH ALL TIMBERTECH PRO® AND TIMBERTECH EDGE™ DECK BOARDS



- Choose from color-matched fasteners available in high-quality, coated carbon steel or stainless steel screws in select colors
- Designed for dense composite material using an 18v drill set at high speed for maximum performance
- Compatible with all TimberTech PRO and EDGE deck boards

PRODUCT DESCRIPTION	TimberTech Model Number		
	85 SQ FT	100 SQ FT	500 SQ FT
<b>TOPLOC FOR TIMBERTECH PRO &amp; TIMBERTECH EDGE</b>			
2½" TOPLoc Screws Ivory	—	TLOC350I	TLOC1750I
2½" TOPLoc Screws Cedar	—	TLOC350C	TLOC1750C
2½" TOPLoc Screws Teak	—	TLOC350T	TLOC1750T
2½" TOPLoc Screws Walnut	—	TLOC350W	TLOC1750W
2½" TOPLoc Screws Light Gray	—	TLOC350LG	TLOC1750LG
2½" TOPLoc Screws Gray	—	TLOC350G	TLOC1750G
2½" TOPLoc Screws Dark Gray	—	TLOC350DG	TLOC1750DG
3" TOPLoc SS Screws Ivory	TLOC300SSI	—	—
3" TOPLoc SS Screws Cedar	TLOC300SSC	—	—
3" TOPLoc SS Screws Teak	TLOC300SST	—	—
3" TOPLoc SS Screws Walnut	TLOC300SSW	—	—
3" TOPLoc SS Screws Light Gray	TLOC300SSLG	—	—
3" TOPLoc SS Screws Gray	TLOC300SSG	—	—
3" TOPLoc SS Screws Dark Gray	TLOC300SSDG	—	—

**TOPLoc® Fascia for PRO® & EDGE™**

Color-matched, stainless steel decking fasteners.

USE WITH ALL TIMBERTECH PRO® AND TIMBERTECH EDGE™ FASCIA BOARDS



- Color-matched stainless steel screw designed to decrease oil-canning
- Compatible with fascia boards from the TimberTech PRO and TimberTech EDGE lines

PRODUCT DESCRIPTION	TimberTech Model Number	
	30 LIN FT	
<b>TOPLOC FASCIA FOR TIMBERTECH PRO &amp; TIMBERTECH EDGE</b>		
1¾" TOPLoc Fascia Screws Ivory 100/Pkg	TLOCFAS100I	
1¾" TOPLoc Fascia Screws Cedar 100/Pkg	TLOCFAS100C	
1¾" TOPLoc Fascia Screws Teak 100/Pkg	TLOCFAS100T	
1¾" TOPLoc Fascia Screws Walnut 100/Pkg	TLOCFAS100W	
1¾" TOPLoc Fascia Screws Light Gray 100/Pkg	TLOCFAS100LG	
1¾" TOPLoc Fascia Screws Gray 100/Pkg	TLOCFAS100G	
1¾" TOPLoc Fascia Screws Dark Gray 100/Pkg	TLOCFAS100DG	
TOPLoc Fascia Drill Bit	TLOCFASBIT	

**Colors:**  
TOPLoc for TimberTech PRO and EDGE Decking & Fascia

**Light Gray:** Stone Ash®, Sea Salt Gray  
**Gray:** Maritime Gray™, Driftwood, Gray\*  
**Dark Gray:** Silver Maple, Ashwood, Espresso™  
**Teak:** Antique Leather™, Pecan, Tigerwood, Dark Teak™, Coconut Husk™

**Walnut:** Brown Oak, Rustic Elm®, Dark Roast™, Mocha  
**Ivory:** Whitewash Cedar®  
**Cedar:** Cedar\*

\*Color-matched to ReliaBoard®



## FUSIONLoc®

Stainless steel clip provides a secure board-to-joist connection with a hidden appearance.

USE WITH ALL TIMBERTECH GROOVED DECK BOARDS



- Collated hidden fastener system engineered for strength and speed
- Offers a pneumatic installation with the FastenMaster FiveShot Tool or manual installation using the FUSIONLoc Hand Driven Guide
- Compatible with all TimberTech grooved deck boards

PRODUCT DESCRIPTION	TimberTech Model Number
<b>FUSIONLOC FOR AZEK, PRO, &amp; EDGE</b>	
FUSIONLoc 225 SF/Pkg (Pneumatic)	FLOC225
FUSIONLoc 450 SF/Pkg (Pneumatic)	FLOC450
FUSIONLoc Hand Driven Guide	FLOCHDGUIDE
FUSIONLoc 50 SF/Pkg (Hand Driven)	FLOCHD50
FUSIONLoc 225 SF/Pkg (Hand Driven)	FLOCHD225

## CONCEALoc®

Screws and clips with a matte brown finish for a hidden appearance.

USE WITH ALL TIMBERTECH GROOVED DECK BOARDS



- Hidden fastener system that can be installed pneumatically with the FastenMaster Tiger Claw Gun or using a drill
- Stainless steel clips for long-term performance
- Compatible with all TimberTech grooved deck boards

PRODUCT DESCRIPTION	TimberTech Model Number
<b>CONCEALOC FOR AZEK, PRO, &amp; EDGE</b>	
CONCEALoc 100 SF/Carion Clips and Screws	CLOCFAST
CONCEALoc 500 SF/Pkg Gun Pail Clips and Screws for Pneumatic	CLOGUNPAIL
CONCEALoc 1000 SF/Bucket Clips and Screws	CLOCBULK
CONCEALoc L-Bracket 50/Pk Brackets and Screws	CLOCLBKT
CONCEALoc Router Bit	CLOCRBIT
CONCEALoc Replacement Screws, 50 Screws	CLOCSCREW

## SIDELoc™

Use SIDELoc guide to drive stainless steel screws to the perfect depth creating an 1/8" board spacing.

USE WITH TIMBERTECH® AZEK® SQUARE SHOULDERED DECK BOARDS



- Hidden fastener system with superior holding power that requires no pre-drilling
- Stainless steel to resist screw shear and installs creating a perfect 1/8" gap
- Compatible with all TimberTech AZEK square shouldered deck boards

PRODUCT DESCRIPTION	TimberTech Model Number		
	100 SQ FT	200 SQ FT	500 SQ FT
<b>SIDELoc FOR AZEK</b>			
1 7/8" SIDELoc 304 Stainless Steel Screws	SLOC100SF188	SLOC200SF188	SLOC500SF188
2 3/8" SIDELoc 316 Marine Grade SS Screws	SLOC100SF238MG	SLOC200SF238MG	SLOC500SF238MG

TOOLS AND ACCESSORIES	TimberTech Model Number
SIDELoc 3" Driver Bits (set of 2)	SLOCBIT
SIDELoc 5 1/2" Guide for standard width AZEK Deck	SLOCGUIDE
SIDELoc 3 1/2" Guide for narrow width AZEK Deck	SLOC350GUIDE
SIDELoc 7 1/4" Extension for wide width AZEK Deck	SLOC725EXT

## Cortex® for AZEK®

Top-down fastener with color-matched plugs made from TimberTech deck boards for the ultimate fastener-free surface.

USE WITH ALL FULL PROFILE TIMBERTECH DECK BOARDS



- A top-down hidden fastener system that features a high-quality, ACQ approved, specialty deck screw with a Torx® ttap® drive system
- Color-matched plugs made from TimberTech decking to hide the fastener (excluding scalloped Terrain, Prime+ Collections, and ReliaBoard®)
- Compatible with all TimberTech full profile deck boards

PRODUCT DESCRIPTION	TimberTech Model Number			
	100 SQ FT	300 SQ FT	100 SF COLLATED	300 SF COLLATED
<b>CORTEX FOR AZEK</b>				
Cortex Screws - Brownstone	CTX100SFBS	CTX300SFBS	CTC100SFBS	CTC300SFBS
Cortex Screws - Kona	CTX100SFKO	CTX300HCKOAT	CTC100SFKO	CTC300SFKO
Cortex Screws - Slate Gray	CTX100SFSG	CTX300SFSG	CTC100SFSG	CTC300SFSG
NEW! Cortex Screws - American Walnut			CTC100SFAW	CTC300SFAW
NEW! Cortex Screws - Castle Gate			CTC100SFCG	CTC300SFCG
Cortex Screws - Coastline	CTX100SFCS	CTX300SFCS	CTC100SFCS	CTC300SFCS
Cortex Screws - Dark Hickory	CTX100SFDH	CTX300SFDH	CTC100SFDH	CTC300SFDH
Cortex Screws - English Walnut	CTX100SFEW	CTX300SFEW	CTC100SFEW	CTC300SFEW
Cortex Screws - Mahogany	CTX100SFMH	CTX300SFMH	CTC100SFMH	CTC300SFMH
Cortex Screws - Weathered Teak	CTX100SFWT	CTX300SFWT	CTC100SFWT	CTC300SFWT
<b>CORTEX FOR AZEK MAX</b>				
Cortex Screws - Slate Gray - AZEK MAX			CTCM100SFSG	
Cortex Screws - Coastline - AZEK MAX			CTCM100SFCS	

## Cortex® for PRO® & EDGE™

Top-down fastener with color-matched plugs made from TimberTech deck boards for the ultimate fastener-free surface.

USE WITH ALL FULL PROFILE TIMBERTECH® PRO® AND TIMBERTECH® EDGE® DECK BOARDS



PRODUCT DESCRIPTION	TimberTech Model Number
<b>CORTEX FOR PRO &amp; EDGE</b>	
Cortex Screws - Dark Teak	CTX100EDT
Cortex Screws - Maritime Gray	CTX100EMG
Cortex Screws - Ashwood	CTX100LCAW
Cortex Screws - Espresso	CTX100LCE
Cortex Screws - Mocha	CTX100LCM
Cortex Screws - Pecan	CTX100LCP
Cortex Screws - Tigerwood	CTX100LCTW
Cortex Screws - Whitewash Cedar	CTX100LCWC
Cortex Screws - Antique Leather	CTX100RCAL
Cortex Screws - Dark Roast	CTX100RCDR
Cortex Screws - Driftwood	CTX100RCDW





TIMBERTECH® COMPOSITE RAILING

Our most popular collection has rightly been dubbed the "Designer Series" of railing. Boasting multiple top rail and infill choices, this simple system gives you endless design options to make your outdoor living space truly yours. Take your home's outdoor space to the next level with its bold details and variety of colors with this railing series.



Photo: Classic Composite Series with Trademark Top Rail in White

### Classic Composite Series

BOLD. BEAUTIFUL. REFINED.

5 top rail options | 3 Color options | 4 infill options



#### DRINK RAIL

Choose a deck board to complement your decking\*

#### RADIANCE RAIL®



#### TRADEMARK RAIL™

Only Available in White and Matte White

#### PREMIER RAILING®



#### CONTEMPORARY RAIL

Contemporary Top Rail only available in the following colors



\*\*Classic Black or Traditional Walnut colors available for Top Rail only. Please note that these colors are different from the five Classic Composite colors and will not be an exact match.



#### Color Options



WHITE

BLACK



MATTE WHITE

Fade & Stain Warranty applies to matte white only

#### Infill Options



COMPOSITE



ALUMINUM

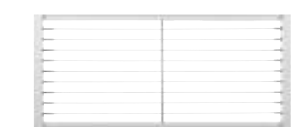

CABLERAIL



GLASS

\*The Drink Rail system works with all full profile, square shouldered deck boards, but NOT with scalloped boards (i.e. Terrain, Prime, Prime+ or ReliaBoard).





## Classic Composite Series Kits, Packs, and Top Rails

PRODUCT DESCRIPTION	TimberTech Model Number		
	WHITE	BLACK	MATTE WHITE
<b>UNIVERSAL RAIL KITS</b> - Kits include 1 Universal Rail, 2 Support Rails, Hardware, Footblocks, and 13 Balusters for 6', 18 Balusters for 8'			
6' Universal Rail Kit	TCU36KIT6W	—	TCU36KIT6MW
8' Universal Rail Kit	TCU36KIT8W	—	TCU36KIT8MW
<b>UNIVERSAL RAIL PACKS</b> - Packs include 1 Universal Rail, 2 Support Rails, Hardware, and Footblocks			
6' Universal Rail Pack	TCURP6W	TCURP6B	TCURP6MW
8' Universal Rail Pack	TCURP8W	TCURP8B	TCURP8MW
10' Universal Rail Pack	TCURP10W	TCURP10B	TCURP10MW
6' Custom Universal Rail Pack - Laser Etched	TCURPCUST6W	TCURPCUST6B	TCURPCUST6MW
8' Custom Universal Rail Pack - Laser Etched	TCURPCUST8W	TCURPCUST8B	TCURPCUST8MW
10' Custom Universal Rail Pack - Laser Etched	TCURPCUST10W	TCURPCUST10B	TCURPCUST10MW
<b>PREMIER TOP RAIL</b>			
6' Premier Top Rail	APTR6W	APTR6B	APTR6MW
8' Premier Top Rail	APTR8W	APTR8B	APTR8MW
10' Premier Top Rail	APTR10W	APTR10B	APTR10MW
<b>RADIANCE RAIL TOP RAIL</b>			
6' RadianceRail Top Rail	TRRTR06W	TRRTR06B	TRRTR06MW
8' RadianceRail Top Rail	TRRTR08W	TRRTR08B	TRRTR08MW
10' RadianceRail Top Rail	TRRTR10W	TRRTR10B	TRRTR10MW
<b>TRADEMARK TOP RAIL</b>			
6' Trademark Top Rail	ATTR6W	—	ATTR6MW
8' Trademark Top Rail	ATTR8W	—	ATTR8MW
10' Trademark Top Rail	ATTR10W	—	ATTR10MW
<b>DRINK RAIL (UNIVERSAL RAIL)</b> - Includes Undrilled Rail and Hardware to attach deck board			
6' Universal Rail	TCUBULKBR6W	TCUBULKBR6B	TCUBULKBR6MW
8' Universal Rail	TCUBULKBR8W	TCUBULKBR8B	TCUBULKBR8MW
10' Universal Rail	TCUBULKBR10W	TCUBULKBR10B	TCUBULKBR10MW

PRODUCT DESCRIPTION	TimberTech Model Number		
	WHITE	BLACK	MATTE WHITE
<b>CLASSIC COMPOSITE SERIES HARDWARE KITS</b>			
Universal Hardware Kit	AZTHWKITRT		
8' Baluster Fastener Kit	AZTFAST8		

PRODUCT DESCRIPTION	TimberTech Model Number	
	CLASSIC BLACK	TRADITIONAL WALNUT
<b>CONTEMPORARY TOP RAIL</b>		
16' Contemporary Top Rail	EVRC16CB	EVRC16TW

## Classic Composite Infills

PRODUCT DESCRIPTION	TimberTech Model Number		
	WHITE	BLACK	MATTE WHITE
<b>COMPOSITE BALUSTERS</b> - 18/Pack			
29" Square Composite Balusters	AZT29BALW	AZT29BALB	AZT29BALMW
31" Square Composite Balusters	AZT31BALW	AZT31BALB	AZT31BALMW
35" Square Composite Balusters	AZT35BALW	AZT35BALB	AZT35BALMW
37" Square Composite Balusters	AZT37BALW	AZT37BALB	AZT37BALMW

PRODUCT DESCRIPTION	TimberTech Model Number			
	ROUND ALUMINUM	ROUND STAIR ALUMINUM	SQUARE ALUMINUM	SQUARE STAIR ALUMINUM
<b>ALUMINUM BALUSTERS</b> - 20/Pack				
29" Use with 36" Rail	AZT29RABALB	—	AZT29SABALB	—
31" Use with 36" Rail	AZT31RABALB	AZT31RASTAIRBALB	AZT31SABALB	AZT31SASTAIRBALB
35" Use with 42" Rail	AZT35RABALB	—	AZT35SABALB	—
37" Use with 42" Rail	AZT37RABALB	AZT37RASTAIRBALB	AZT37SABALB	AZT37SASTAIRBALB

Required number of Balusters for Composite: 23 per 10' section, 18 per 8' section, 13 per 6' section.

Required number of Balusters for Aluminum: 25 per 10' section, 20 per 8' section, 15 per 6' section.

## Classic Composite Infills(Continued)

PRODUCT DESCRIPTION	TimberTech Model Number		
	WHITE	BLACK	MATTE WHITE
<b>CABLERRAIL KITS</b>			
36" CableRail Hardware Kit - 9 Quick-Connect fittings, 9 Quick-Connect swivel fittings, 18 Hanger Bolts, 9 Lock Nuts	AZTCR36HWKIT		
42" CableRail Hardware Kit - 11 Quick-Connect fittings, 11 Quick-Connect swivel fittings, 22 Hanger Bolts, 11 Lock Nuts	AZTCR42HWKIT		
36" CableRail Intermediate Baluster - 9-Hole Baluster, Intermediate Base Plate, #10X2" Pan Head Screw, (3) #10X1" Flat Head Screws	AZTCR36BAL		
42" CableRail Intermediate Baluster - 11-Hole Baluster, Intermediate Base Plate, #10X2" Pan Head Screw, (3) #10X1" Flat Head Screws	AZTCR42BAL		
36" CableRail Stair Intermediate Baluster - Angled 9-Hole Baluster, Intermediate Base Plate, #10X2" Pan Head Screw, (3) #10X1" Flat Head Screws	AZTCR36STAIRBAL		
42" CableRail Stair Intermediate Baluster - Angled 11-Hole Baluster, Intermediate Base Plate, #10X2" Pan Head Screw, (3) #10X1" Flat Head Screws	AZTCR42STAIRBAL		
CableRail 100' Stainless Steel Cable	AZTCR100CABLE		
CableRail 500' Stainless Steel Cable	AZTCR500CABLE		
CableRail Accessory Kit	AZTCRACKKIT		
CableRail Cutter	AZTCRCUTTER		
CableRail Protector Sleeves (20/Pg)	AZTCRSLEEVE		
CableRail SteelRenewal™ SteelProtect™ Combo	AZTCRSRSPC		
<b>GLASS CHANNEL KITS</b>			
6' Glass Channel Kit White - Glass Panel Sourced Locally	AZTGLASS6W		
6' Glass Channel Kit Black - Glass Panel Sourced Locally	AZTGLASS6B		

## Classic Composite Post Sleeves, Caps, Skirts

PRODUCT DESCRIPTION	TimberTech Model Number		
	WHITE	BLACK	MATTE WHITE
<b>POST SLEEVES</b>			
4" x 4" x 39" Post Sleeve	AZT4X4PCV39W	AZT4X4PCV39B	AZT4X4PCV39MW
4" x 4" x 96" Post Sleeve	AZT4X4PCV96W	AZT4X4PCV96B	AZT4X4PCV96MW
5" x 5" x 42" Post Sleeve	T5X5PCV42W	T5X5PCV42B	T5X5PCV42MW
5" x 5" x 144" Post Sleeve	T5X5PCV144W	T5X5PCV144B	T5X5PCV144MW
5.5" x 5.5" x 39" Post Sleeve	A55X55PCV39W	A55X55PCV39B	A55X55PCV39MW
5.5" x 5.5" x 54" Post Sleeve	A55X55PCV54W	A55X55PCV54B	A55X55PCV54MW
5.5" x 5.5" x 144" Post Sleeve	A55X55PCV144W	A55X55PCV144B	A55X55PCV144MW
<b>POST CAPS AND SKIRTS</b>			
4" x 4" Post Cap	TX4X4PCAPW	TX4X4PCAPB	TX4X4PCAPMW
4" x 4" Island Cap	TX4X4ICAPW	TX4X4ICAPB	TX4X4ICAPMW
4" x 4" Post Skirt	AZT4X4PSKIRTW	AZT4X4PSKIRTB	AZT4X4PSKIRTMW
5" x 5" Post Cap	T5X5PCAPW	T5X5PCAPB	T5X5PCAPMW
5" x 5" Post Skirt	T5X5PSKIRTW	T5X5PSKIRTB	T5X5PSKIRTMW
5.5" x 5.5" Pyramid Cap	A55X55PCAPW	A55X55PCAPB	A55X55PCAPMW
5.5" x 5.5" Island Cap	A55X55ICAPW	A55X55ICAPB	A55X55ICAPMW
5.5" x 5.5" Post Skirt	A55X55PSKIRTW	A55X55PSKIRTB	A55X55PSKIRTMW

A 5.5"x5.5" post sleeve is required for applications with 45° or other angled cuts.

## Classic Composite Support Rails

PRODUCT DESCRIPTION	TimberTech Model Number	
	WHITE	BLACK
<b>CUSTOM SUPPORT RAILS</b> - Laser-Etched for Aluminum Balusters		
8' Custom Support Rails	AZTBULKSR8W	AZTBULKSR8B
<b>CUSTOM SUPPORT RAILS</b> - Blank for 10' Bottom Support Rails		
10' Custom Support Rails	AZTBULKUDSR10W	AZTBULKUDSR10B
<b>ALUMINUM SUPPORT RAILS</b> - Drilled for Composite Balusters		
10' Aluminum Support Rails	AZTBULKSR10W	AZTBULKSR10B
<b>CUSTOM ALUMINUM SUPPORT RAILS</b> - Marked for Aluminum Balusters		
10' Custom Aluminum Support Rails	AZTBULKCUSTR10W	AZTBULKCUSTR10B



# Composite Railing

How to Order:

1 Select preferred style and color

2 Select preferred infill

3 Select post sleeve and finishing touches — caps, skirts, lighting

## 1. STYLES AND COLORS

### Classic Composite Series



**Premier Railing®**  
3.5"W x 2.7"H



**RadianceRail®**  
2.9"W x 2.9"H



**Trademark Rail™**  
3.5"W x 2.7"H  
Only available in White



**Drink Rail**  
Compatible with full profile, square-shoulder boards  
• TimberTech AZEK Boards 5.5"W x 1"H  
• TimberTech PRO & EDGE Premier Collection Boards 5.36"W x .94"H

#### Color Options



WHITE BLACK



MATTE WHITE

Fade & Stain Warranty applies to matte white only



**Contemporary Rail**  
6.4"W x 3"H  
Only available in Classic Black and Traditional Walnut



TRADITIONAL WALNUT CLASSIC BLACK

## 2. INFILLS

1.25" x 1.25" Composite

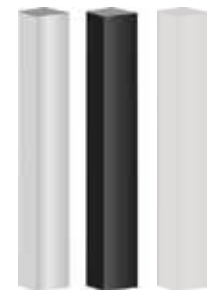

.75" x .75" Aluminum Round and Square Black Only



Glass Channel to fit 1/4" Tempered Glass



CableRail

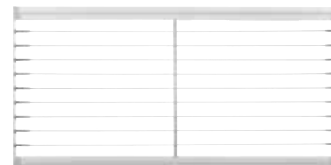

Available in 4" x 4" 5" x 5" 5.5" x 5.5"



## 3. POSTS SLEEVES

## 3. CAPS AND SKIRTS

4" x 4" Cap 5.63" x 5.63" Profile



4" x 4" Island Cap 7.1" x 7.1" Profile



5" x 5" Cap 7.11" x 7.11" Profile



5.5" x 5.5" Island Cap 8.32" x 8.32" Profile



5.5" x 5.5" Pyramid Cap 8.32" x 8.32" Profile



4" x 4" Skirt 5.42" x 5.42" Profile



5" x 5" Skirt 6.36" x 6.36" Profile



5.5" x 5.5" Skirt 8.0" x 8.0" Profile



4" x 4" Skirt 5.42" x 5.42" Profile



5" x 5" Skirt 6.36" x 6.36" Profile



5.5" x 5.5" Skirt 8.0" x 8.0" Profile



## 3. LIGHTING

5.5" x 5.5" Lighted Island Cap 8.32" x 8.32" Profile



4" x 4", 5" x 5", 5.5" x 5.5" Post Cap Light



Accent Lights (Available in white or architectural bronze)



Under Rail Lights



Accent Lights (Available in white or architectural bronze)





## RadianceRail Express®

SIMPLE. SCULPTED. TIMELESS.



Rail Packs are available in different lengths for level and stair applications with baluster options to accommodate a 36" or 42" railing height. RadianceRail Express pairs with the 4" x 4" Post Sleeve.

RadianceRail Express gaskets are included the level Rail Packs, and RadianceRail Express hardware is included in all Rail Packs. Hardware and gaskets are also offered separately for installing two shorter sections while using one Rail Pack and for replacements.

## Builder Rail

BOLD. MODERN. IMPACTFUL.



For a top rail, select standard width, full profile, square-shoulder deck boards.

PRODUCT DESCRIPTION	TimberTech Model Number		
	WHITE	BLACK	KONA
<b>RADIANCE RAIL EXPRESS SMART SETS</b> - Includes Top & Bottom Rail, 4x4 Post Sleeve, 4" Post Cap, 4" Post Skirt, Hardware, Footblocks, 13 Balusters for 6', 18 Balusters for 8'			
6' RadianceRail Express Smart Set	TXSS6W	—	—
6' RadianceRail Express Stair Smart Set	TXSSS6W	—	—
8' RadianceRail Express Smart Set	TXSS8W	—	—
8' RadianceRail Express Stair Smart Set	TXSSS8W	—	—
<b>RADIANCE RAIL EXPRESS PACKS</b> Packs include Top & Bottom Rail, Hardware, Gaskets, and Footblocks			
6' RadianceRail Express Pack	TXRP6W	TXRP6B	TXRP6K
8' RadianceRail Express Pack	TXRP8W	TXRP8B	TXRP8K
<b>RADIANCE RAIL EXPRESS STAIR PACKS</b> Packs include Top & Bottom Rail, Hardware, and Footblocks			
8' RadianceRail Express Stair Pack	TXSRP8W	TXSRP8B	TXSRP8K
<b>RADIANCE RAIL EXPRESS ROUND ALUMINUM BALUSTER (RAB) RAIL PACKS</b> Packs include Top & Bottom Rail, Hardware and Footblocks			
6' RadianceRail Express RAB Pack	TXRPAB6W	TXRPAB6B	TXRPAB6K
8' RadianceRail Express RAB Pack	TXRPAB8W	TXRPAB8B	TXRPAB8K
<b>RADIANCE RAIL EXPRESS ROUND ALUMINUM BALUSTER (RAB) STAIR PACKS</b> Packs include Top & Bottom Rail, Hardware, and Footblocks			
8' RadianceRail Express RAB Stair Pack	TXSRPRAB8W	TXSRPRAB8B	TXSRPRAB8K
<b>RADIANCE RAIL EXPRESS COMPOSITE BALUSTERS - 18/Pack</b>			
29.75" Square Composite Baluster	TX30BALW	TX30BALB	TX30BALK
35.75" Square Composite Baluster	TX36BALW	TX36BALB	TX36BALK
<b>RADIANCE RAIL ROUND ALUMINUM BALUSTERS - 18/Pack</b>			
29" Round Aluminum Balusters	—	TX30RABALB	—
35" Round Aluminum Balusters	—	TX36RABALB	—
<b>RADIANCE RAIL EXPRESS POST SLEEVES</b>			
4" x 4" x 39" Post Sleeve	AZT4X4PCV39W	AZT4X4PCV39B	AZT4X4PCV39K
4" x 4" x 96" Post Sleeve	AZT4X4PCV96W	AZT4X4PCV96B	AZT4X4PCV96K
<b>RADIANCE RAIL EXPRESS POST CAPS AND SKIRTS</b>			
4" x 4" Post Cap	TX4X4PCAPW	TX4X4PCAPB	TX4X4PCAPK
4" x 4" Island Cap	TX4X4ICAPW	TX4X4ICAPB	TX4X4ICAPK
4" x 4" Post Skirt	AZT4X4PSKIRTW	AZT4X4PSKIRTB	AZT4X4PSKIRTK
<b>RADIANCE RAIL EXPRESS HARDWARE KITS</b>			
Mounting Kit	TXBKTITW	TXBKTITB	TXBKTITK
Mounting Kit for Stairs	TXBKTSTAIRKITW	TXBKTSTAIRKITB	TXBKTSTAIRKITK
Gasket Pack Kit - Includes 4 gaskets	TXGSTPKW	TXGSTPKB	TXGSTPKK

Required number of balusters for composite: 23 per 10' section, 18 per 8' section, 13 per 6' section.

Required number of balusters for composite stairs: 14 per 8' section, 11 per 6' section.

\*Additional Post Sleeves, Post Caps, and Post Skirts may be purchased separately if needed.

PRODUCT DESCRIPTION	TimberTech Model Number	
	CLASSIC BLACK	TRADITIONAL WALNUT
<b>BUILDER RAIL BOARD</b> - Packaged as (2) 6' boards		
6' 2x4 Builder Rail Board	BB2406CB	BB2406TW
8' 2x4 Builder Rail Board	BB2408CB	BB2408TW
<b>BUILDER RAIL HARDWARE KITS</b> - Used for Level and Stair Applications		
Mounting Kit	EVHWKITCB	EVHWKITTW
<b>BUILDER RAIL POST SLEEVES</b>		
42" Builder Rail 5"x5" Post Sleeves	EV5X5PCV42CB	EV5X5PCV42TW
8" Builder Rail 5"x5" Post Sleeves	EV5X5PCV8CB	EV5X5PCV8TW
<b>BUILDER RAIL POST SKIRTS</b>		
Builder Rail 5"x5" Post Skirt	EV5X5PSKIRTCB	EV5X5PSKIRTTW
<b>BUILDER RAIL FOOT BLOCKS</b>		
Builder Rail Foot Block	EVFBCB	EVFBTW

PRODUCT DESCRIPTION	TimberTech Model Number	
	BLACK	
<b>BUILDER RAIL METAL BALUSTERS - 20/Pack</b>		
36" Round Metal Baluster Pack - 25" Baluster Height	BRMB36KITBCM	
36" Round Metal Baluster Pack - 23.75" Baluster Height	BRMB36STAIRBCM	
42" Round Metal Baluster Pack - 31" Baluster Height	BRMB42KITBCM	
42" Round Metal Baluster Pack - 29.75" Baluster Height	BRMB42STAIRBCM	

## Reserve Rail™

CLASSIC. STATELY. POWERFUL.



Reserve Rail available regionally



PRODUCT DESCRIPTION	TimberTech Model Number	
	WHITE	
<b>RESERVE RAIL PACKS</b> - Packs include Bottom Rail, 2 Support Rails, Hardware, and Footblocks (Top Rail sold separately)		
6' Reserve Rail Pack	ARRP6W	
8' Reserve Rail Pack	ARRP8W	
10' Reserve Rail Pack	ARRP10W	
<b>RESERVE CUSTOM RAIL PACKS</b> - Packs include Bottom Rail, 2 Support Rails, Hardware, and Footblocks. For use with custom infill: Glass Channels, CableRail, or Aluminum Balusters (Top Rail sold separately)		
6' Reserve Rail Custom Pack	ARCUST6W	
8' Reserve Rail Custom Pack	ARCUST8W	
10' Reserve Rail Custom Pack	ARCUST10W	
<b>RESERVE RAIL TOP RAIL</b> - Sold separately for safe efficient shipping and over the post installs		
6' Reserve Top Rail	AR55TR6W	
8' Reserve Top Rail	AR55TR8W	
10' Reserve Top Rail	AR55TR10W	
16' Reserve Top Rail	AR55TR16W	
<b>RESERVE RAIL COMPOSITE BALUSTERS - 18/Pack</b>		
29" Square Composite Baluster	AR29BALW	
31" Square Composite Baluster	AR31BALW	
35" Square Composite Baluster	AR35BALW	
37" Square Composite Baluster	AR37BALW	

PRODUCT DESCRIPTION	TimberTech Model Number			
	ROUND ALUMINUM	ROUND STAIR ALUMINUM	SQUARE ALUMINUM	SQUARE STAIR ALUMINUM
<b>ALUMINUM BALUSTERS - 20/Pack</b>				
29" Use with 36" Rail	AZT29RABALB	—	AZT29SABALB	—
31" Use with 36" Rail	AZT31RABALB	AZT31RASTAIRBALB	AZT31SABALB	AZT31SASTAIRBALB
35" Use with 42" Rail	AZT35RABALB	—	AZT35SABALB	—
37" Use with 42" Rail	AZT37RABALB	AZT37RASTAIRBALB	AZT37SABALB	AZT37SASTAIRBALB

PRODUCT DESCRIPTION	TimberTech Model Number	
	WHITE	
<b>CABLE RAIL KITS</b>		
36" CableRail Hardware Kit - 9 Quick-Connect fittings, 9 Quick-Connect swivel fittings, 18 Hanger Bolts, 9 Lock Nuts	AZTCR36HWKIT	
42" CableRail Hardware Kit - 11 Quick-Connect fittings, 11 Quick-Connect swivel fittings, 22 Hanger Bolts, 11 Lock Nuts	AZTCR42HWKIT	
36" CableRail Intermediate Baluster - 9-Hole Baluster, Intermediate Base Plate, #10X2" Pan Head Screw, (3) #10X1" Flat Head Screws	AZTCR36BAL	
42" CableRail Intermediate Baluster - 11-Hole Baluster, Intermediate Base Plate, #10X2" Pan Head Screw, (3) #10X1" Flat Head Screws	AZTCR42BAL	
36" CableRail Stair Intermediate Baluster - Angled 9-Hole Baluster, Intermediate Base Plate, #10X2" Pan Head Screw, (3) #10X1" Flat Head Screws	AZTCR36STAIRBAL	
42" CableRail Stair Intermediate Baluster - Angled 11-Hole Baluster, Intermediate Base Plate, #10X2" Pan Head Screw, (3) #10X1" Flat Head Screws	AZTCR42STAIRBAL	
CableRail 100' Stainless Steel Cable	AZTCR100CABLE	
CableRail 500' Stainless Steel Cable	AZTCR500CABLE	
CableRail Accessory Kit	AZTCRACKKIT	
CableRail Cutter	AZTCRCUTTER	
CableRail Protector Sleeves (20/Pg)	AZTCRSLEEVE	
CableRail Steel Renewal™ SteelProtect™ Combo	AZTCRSRSPC	
<b>GLASS CHANNEL KITS</b>		
6' Glass Channel Kit White - Glass Panel Sourced Locally	AZTGLASS6W	
6' Glass Channel Kit Black - Glass Panel Sourced Locally	AZTGLASS6B	
<b>RESERVE RAIL POST SLEEVES</b>		
4" x 4" x 39" Post Sleeve	AZT4X4PCV39W	
4" x 4" x 96" Post Sleeve	AZT4X4PCV96W	
6" x 6" x 108" Post Sleeve	A6X6PCV108W	
<b>RESERVE RAIL POST CAPS AND SKIRTS</b>		
4" x 4" Post Skirt	AZT4X4PSKIRTW	
6" x 6" Post Cap	A6X6PCAPW	
6" x 6" Post Skirt	A6X6PSKIRTW	

Reserve Rail is available in Rail Packs only to allow for more customization of colors and infill styles. Post sleeve options include the preferred 6"x6" post sleeve and a 4"x4" post sleeve with a longer top rail for over the post applications. Note: Top rails are sold separately from Rail Packs.

Required number of balusters for composite: 23 per 10' section, 18 per 8' section, 13 per 6' section.

Required number of balusters for aluminum: 25 per 10' section, 20 per 8' section, 15 per 6' section.



# Composite Railing

How to Order:

1 Select preferred style and color

2 Select preferred infill

3 Select post sleeve and finishing touches — caps, skirts, lighting

## 1. STYLES AND COLORS

### Reserve Rail™

5.4"W x 2.7"H

Color Option



WHITE

Reserve Rail styles are available in select markets.



## 2. INFILLS

1.25" x 1.25"  
Composite



Glass Channel to fit  
1/4" Tempered Glass



.75" x .75" Aluminum  
Round and Square  
Black Only



CableRail

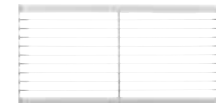

## 3. POSTS SLEEVES

Available in  
4" x 4" (for over the  
post installation)  
6" x 6"



## 3. CAPS AND SKIRTS

6" x 6" Cap  
7.11" x 7.11" Profile



6" x 6" Skirt  
9.04" x 9.04" Profile



4" x 4" Skirt  
5.42" x 5.42" Profile



## 3. LIGHTING

Accent Lights  
(Available in white or  
architectural bronze)



Under Rail Lights



### RadianceRail Express®

2.7"W x 2.4"H

Color Options



WHITE



KONA®



BLACK



1.25" x 1.25"  
Composite



.75" x .75"  
Metal Round



Available in  
4" x 4"



4" x 4" Cap  
5.63" x 5.63" Profile



4" x 4" Island Cap  
7.1" x 7.1" Profile



4" x 4" Skirt  
5.42" x 5.42" Profile



Accent Lights  
(Available in white or  
architectural bronze)



4" x 4" Post Cap Light



### Builder Rail

5.36"W x 4.34"H

Color Options



CLASSIC  
BLACK



TRADITIONAL  
WALNUT



.75" x .75"  
Metal Round



Glass Channel to fit  
1/4" Tempered Glass



Available in  
5" x 5"



5" x 5" Skirt  
5.375" x 5.375" Profile



Accent Lights  
(Available in white or  
architectural bronze)



Select square shoulder deck board for Top Rail



**TIMBERTECH® METAL RAILING**

Keep your sightlines clear and your design lines sleek with these minimalist metal railings. Designed for style and safety, decks with these railings gain an added air of sophistication. Railing is the first thing neighbors see when they peek into each other's yards, so make a style statement with a minimalist metal railing.

Photo: Impression Rail Express® in Black



**Impression Rail™**

MODERN. STURDY. MINIMALIST.



TOP RAIL SIZE:  
1.8" X 1.6"

**Color Options**



**Impression Rail Kits, Stair Kits, and Post Kits**

PRODUCT DESCRIPTION	TimberTech Model Number	
	BLACK	BRONZE
<b>IMPRESSION RAIL KITS</b> - Kits include Top & Bottom Rail, Balusters, Level Brackets, Hardware and Footblocks		
36" 6' Level Rail Kit - 16 Aluminum Balusters included	AZTIR36KIT6B	AZTIR36KIT6BR
42" 6' Level Rail Kit - 16 Aluminum Balusters included	AZTIR42KIT6B	AZTIR42KIT6BR
36" 8' Level Rail Kit - 22 Aluminum Balusters included	AZTIR36KIT8B	AZTIR36KIT8BR
42" 8' Level Rail Kit - 22 Aluminum Balusters included	AZTIR42KIT8B	AZTIR42KIT8BR
36" 10' Level Rail Kit - 27 Aluminum Balusters included	AZTIR36KIT10B	AZTIR36KIT10BR
42" 10' Level Rail Kit - 27 Aluminum Balusters included	AZTIR42KIT10B	AZTIR42KIT10BR
<b>IMPRESSION RAIL STAIR KITS</b> - Stair kits include Top & Bottom Rail, Balusters, 35° Stair Brackets, Hardware, and Footblocks		
36" 8' Stair Rail Kit - 22 Aluminum Balusters included	AZTIR36SKIT8B	AZTIR36SKIT8BR
42" 8' Stair Rail Kit - 22 Aluminum Balusters included	AZTIR42SKIT8B	AZTIR42SKIT8BR
<b>IMPRESSION RAIL POST KIT</b> - Includes Post, Cap, and Skirt		
2" x 2" - 37" Post Kit for 36" Rail	AZTIR2X2PK37B	AZTIR2X2PK37BR
2" x 2" - 43" Post Kit for 36" Stairs or 42" Level	AZTIR2X2PK43B	AZTIR2X2PK43BR
2" x 2" - 54" Post Kit for 42" Stairs	AZTIR2X2PK54B	AZTIR2X2PK54BR
3" x 3" - 38" Post Kit for 36" Rail	AZTIR3X3PK38B	AZTIR3X3PK38BR
3" x 3" - 44" Post Kit for 36" Stairs or 42" Level	AZTIR3X3PK44B	AZTIR3X3PK44BR
3" x 3" - 54" Post Kit for 42" Stairs	AZTIR3X3PK54B	AZTIR3X3PK54BR
3" x 3" Commercial - 44" Post Kit for 42" IBC Rail	AZTIR3X3CPK44B	—
<b>IMPRESSION RAIL OVER THE POST</b> - Includes Skirt and Over-the-Post Bracket		
2" x 2" - For 36" Level Rail	AZTIR2X2OTPL36B	AZTIR2X2OTPL36BR
2" x 2" - For 36" Fixed Stair Rail	AZTIR2X2OTPS36B	AZTIR2X2OTPS36BR
<b>IMPRESSION RAIL BRACKET KITS</b> - Set of 4		
Level Rail Bracket Kit - 2 Top, 2 Bottom	AZTIRBKTKITB	AZTIRBKTKITBR
Level Rail 45° Bracket Kit - 2 Top, 2 Bottom	AZTIRBKT45KITB	AZTIRBKT45KITBR
Level Rail 22½° Bracket Kit - 2 Top, 2 Bottom	AZTIRBKT22KITB	AZTIRBKT22KITBR
Level Rail 4" Site Cut Bracket Kit - 2 Top, 2 Bottom	AZTIRBKTSCKITB	AZTIRBKTSCKITBR
Fixed Stair Bracket Kit - 2 Top, 2 Bottom for 34° Stairs	AZTIRSBKTFKITB	AZTIRSBKTFKITBR
Adjustable Stair Rail Bracket Kit	AZTIRSBKTKITB	AZTIRSBKTKITBR
<b>IMPRESSION RAIL FASTENER KIT</b>		
Fastener Kit for Composite Posts & Top Rail	AZTIRCFASTKITB	—
<b>IMPRESSION RAIL TOOLS</b>		
Installation Tool (Pre-drilling template for 2" & 3" post)	AZTIRIT	—
Touch-Up Paint	AZTIRTUPB	AZTIRTUPBR
2" Mounting Plate	AZTIR2X2MP	—
3" Mounting Plate	AZTIR3X3MP	—

Rail Kits include aluminum top and bottom rails, brackets, hardware and rectangular balusters. Posts kits are available in 2" and 3" and include a pyramid post cap and post skirt. Impression Rail can also be used with composite post sleeves and RadianceRail top rail for customization.





## Impression Rail Express® Series

CONTEMPORARY. STRONG. UNOBSTRUCTIVE.

### CLASSIC

TOP RAIL SIZE  
2.5" X 2.3"



### NEW! MODERN

TOP RAIL SIZE  
2.25" X 1.8"



### DRINK RAIL

TOP RAIL SIZE  
2.7" X 5.5"



### Color Options

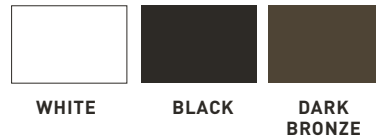

WHITE

BLACK

DARK BRONZE

## Impression Rail Express Panels

PRODUCT DESCRIPTION	TimberTech Model Number		
	WHITE	BLACK	DARK BRONZE
<b>IMPRESSION RAIL EXPRESS STANDARD UNIVERSAL PANEL - Baluster Panel, Bottom Rail, Bracket Hardware, Footblocks (TOP RAIL NOT INCLUDED)</b>			
36" 6' Level Universal Panel - 15 Baluster Panel	AZTIX36UNLP6W	AZTIX36UNLP6B	AZTIX36UNLP6BR
42" 6' Level Universal Panel- 15 Baluster Panel	AZTIX42UNLP6W	AZTIX42UNLP6B	AZTIX42UNLP6BR
36" 8' Level Universal Panel - 20 Baluster Panel	AZTIX36UNLP8W	AZTIX36UNLP8B	AZTIX36UNLP8BR
42" 8' Level Universal Panel - 20 Baluster Panel	AZTIX42UNLP8W	AZTIX42UNLP8B	AZTIX42UNLP8BR
<b>IMPRESSION RAIL EXPRESS STANDARD UNIVERSAL STAIR PANEL - Baluster Panel, Bottom Rail, Bracket Hardware, Footblocks (TOP RAIL NOT INCLUDED)</b>			
36" 6' Stair Universal Panel - 15 Baluster Panel	AZTIX36UNSP6W	AZTIX36UNSP6B	AZTIX36UNSP6BR
42" 6' Stair Universal Panel- 15 Baluster Panel	AZTIX42UNSP6W	AZTIX42UNSP6B	AZTIX42UNSP6BR
36" 8' Stair Universal Panel - 20 Baluster Panel	AZTIX36UNSP8W	AZTIX36UNSP8B	AZTIX36UNSP8BR
42" 8' Stair Universal Panel - 20 Baluster Panel	AZTIX42UNSP8W	AZTIX42UNSP8B	AZTIX42UNSP8BR
<b>IMPRESSION RAIL EXPRESS UNIVERSAL GLASS PANEL KIT - (1/4" Tempered Glass sold separately)</b>			
Universal Glass Panel Kit	AZTIXUGLASSP6W	AZTIXUGLASSP6B	AZTIXUGLASSP6BR
Universal Glass Slats Kit	AZTIXUGLASSSL6W	AZTIXUGLASSSL6B	AZTIXUGLASSSL6BR
Glass Panel Extra Bracket Kit	AZTIXGBTKITW	AZTIXGBTKITB	AZTIXGBTKITBR
Glass Level 22½° Bracket Kit	AZTIXGBKT22KITW	AZTIXGBKT22KITB	AZTIXGBKT22KITBR

## Top Rails

TOP RAILS (for Drink Rail please refer to "Drink Rail and Custom Top Rail Components" below)			
6' Classic Top Rail	AZTIXCSTR6W	AZTIXCSTR6B	AZTIXCSTR6BR
8' Classic Top Rail	AZTIXCSTR8W	AZTIXCSTR8B	AZTIXCSTR8BR
6' Modern Top Rail	AZTIXMDTR6W	AZTIXMDTR6B	AZTIXMDTR6BR
8' Modern Top Rail	AZTIXMDTR8W	AZTIXMDTR8B	AZTIXMDTR8BR
DRINK RAIL AND CUSTOM TOP RAIL COMPONENTS			
6' Universal Panel Cover (for drink rail and open mid-rail)	AZTBULKIXBR6W	AZTBULKIXBR6B	AZTBULKIXBR6BR
8' Universal Panel Cover (for drink rail and open mid-rail)	AZTBULKIXBR8W	AZTBULKIXBR8B	AZTBULKIXBR8BR
6' Unpunched Support Channel for open mid-rail*	AZTBULKIXCHN6W	AZTBULKIXCHN6B	AZTBULKIXCHN6BR
8' Unpunched Support Channel For open mid-rail*	AZTBULKIXCHN8W	AZTBULKIXCHN8B	AZTBULKIXCHN8BR
Drink Rail Kit -12 Clips with Screws (3 clips/6' section & 4 clips/8' section)	AZTIXDRCKITW	AZTIXDRCKITB	AZTIXDRCKITBR
Drink Rail 3" Post Insert - 8 pack (works for all colors)		AZTIX3X3PPLG	

## Post Kits and Accessories

Rail panels include balusters, top and bottom rails, and hardware to fasten the railing to the posts. 3" Post kits include cap and skirt. 2" posts kits include bracket to run rail over the post and skirt.

PRODUCT DESCRIPTION	TimberTech Model Number		
	WHITE	BLACK	DARK BRONZE
<b>IMPRESSION RAIL EXPRESS STANDARD 3" POST KIT - Includes Post, Cap, and Skirt</b>			
38" x 3" x 3" Post Kit	AZTIX3X3PK38W	AZTIX3X3PK38B	AZTIX3X3PK38BR
43" x 3" x 3" Post Kit	AZTIX3X3PK43W	AZTIX3X3PK43B	AZTIX3X3PK43BR
48" x 3" x 3" Post Kit	AZTIX3X3PK48W	AZTIX3X3PK48B	AZTIX3X3PK48BR
<b>IMPRESSION RAIL EXPRESS ALUMINUM POST SKIRTS</b>			
2-Piece Aluminum Post Skirt for 3" Post	AZTIX3X3SKTALW	AZTIX3X3SKTALB	AZTIX3X3SKTALBR
<b>IMPRESSION RAIL EXPRESS® 3" FASCIA MOUNT POST KITS AND BRACKET KITS - Includes Post, Cap, and Skirt</b>			
Fascia Mount 52" Post Kit (post, cap and base insert)	AZTIX3X3FP52W	AZTIX3X3FP52B	AZTIX3X3FP52BR
Fascia Mount Bracket Kit Straight	AZTIX3X3FBSW	AZTIX3X3FBSB	AZTIX3X3FBSBR
Fascia Mount Bracket Outside Corner	AZTIX3X3FBOCW	AZTIX3X3FBOCB	AZTIX3X3FBOCBR
Fascia Mount Bracket Inside Corner	AZTIX3X3FBICW	AZTIX3X3FBICB	AZTIX3X3FBICBR
<b>IMPRESSION RAIL EXPRESS 4" POST COMPONENTS</b>			
4" x 39" Post Sleeve	AZTIX4x4PS39W	AZTIX4x4PS39B	AZTIX4x4PS39BR
4" x 48" Post Sleeve	AZTIX4x4PS48W	AZTIX4x4PS48B	AZTIX4x4PS48BR
4" x 108" Post Sleeve	AZTIX4x4PS108W	AZTIX4x4PS108B	AZTIX4x4PS108BR
4" Post Cap	AZTIX4x4PCW	AZTIX4x4PCB	AZTIX4x4PCBR
4" Post skirt (2 piece polymer based skirt)	AZTIX4x4PSKW	AZTIX4x4PSKB	AZTIX4x4PSKBR
<b>IMPRESSION RAIL EXPRESS OVER-THE-POST 2" POST KIT</b>			
36" x 2" x 2" Over-the-Post Bracket & Skirt	AZTIX2X2PK36W	AZTIX2X2PK36B	AZTIX2X2PK36BR
42" x 2" x 2" Over-the-Post Bracket & Skirt	AZTIX2X2PK42W	AZTIX2X2PK42B	AZTIX2X2PK42BR
18' Classic Top Rail	AZTBULKIXTR18W	AZTBULKIXTR18B	AZTBULKIXTR18BR
<b>NEW!</b> 18' Modern Top Rail	AZTIXBMDTR18W	AZTIXBMDTR18B	AZTIXBMDTR18BR

## Decorative Collars

PRODUCT DESCRIPTION	TimberTech Model Number		
	WHITE	BLACK	DARK BRONZE
<b>NEW! DECORATIVE COLLARS</b>			
Decorative Collar Kit - Classic (2 top rail & 2 bottom rail collars)	AZTIXLCVRKITW	AZTIXLCVRKITB	AZTIXLCVRKITBR
35° Stair Decorative Collar Kit - Classic (2 top rail & 2 bottom rail collars)*	AZTIXSCVRKITW	AZTIXSCVRKITB	AZTIXSCVRKITBR
Level Classic Top Rail Decorative Collar Bulk (30 Classic top rail collars)*	AZTIXLTCVR30W	AZTIXLTCVR30B	AZTIXLTCVR30BR
35° Stair Classic Top Rail Decorative Collar Bulk (30 Classic Top rail collars)*	AZTIXSTCVR30W	AZTIXSTCVR30B	AZTIXSTCVR30BR
Level Decorative Collar Kit - Modern (2 top rail & 2 bottom rail collars)*	AZTIXLMDCKITW	AZTIXLMDCKITB	AZTIXLMDCKITBR
35° Stair Decorative Collar Kit - Modern (2 top rail & 2 bottom rail collars)*	AZTIXSMDCKITW	AZTIXSMDCKITB	AZTIXSMDCKITBR
Level Modern Top Rail Decorative Collar Bulk (30 Modern top rail collars)*	AZTIXLTMDDC30W	AZTIXLTMDDC30B	AZTIXLTMDDC30BR
35° Stair Modern Top Rail Decorative Collar Bulk (30 Modern Top Rail collars)	AZTIXSTMDDC30W	AZTIXSTMDDC30B	AZTIXSTMDDC30BR
Level Bottom Rail Decorative Collar Bulk (30 Bottom Rail collars)*	AZTIXLBCVR30W	AZTIXLBCVR30B	AZTIXLBCVR30BR
35° Stair Bottom Rail Decorative Collar Bulk (30 bottom rail collars)*	AZTIXSBCVR30W	AZTIXSBCVR30B	AZTIXSBCVR30BR

## Installation Tools and Brackets

<b>IMPRESSION RAIL EXPRESS INSTALLATION TOOLS &amp; BRACKETS</b>			
Touch-Up Paint and Bracket Jig - <b>Order at least 1 per job</b>	AZTIXACCKITW	AZTIXACCKITB	AZTIXACCKITBR
Wall Mount Kit	AZTIXWBKTKITW	AZTIXWBKTKITB	AZTIXWBKTKITBR
Extra Bracket Kit Level and Stair	—	AZTIXBKTKIT	—
Level 22.5° Angle Bracket Kit	—	AZTIXBKT22KIT	—
Level 45° Angle Wall Bracket Kit	—	AZTIXWBKT45KIT	—

# Metal Railing

How to Order:

1 Select preferred style and color

2 Select preferred infill

3 Select post sleeve and finishing touches — caps, skirts, lighting

## 1. STYLES AND COLORS

### Impression Rail™

1.8"W x 1.6"T

Color Options



### Impression Rail Express® Series

Color Options

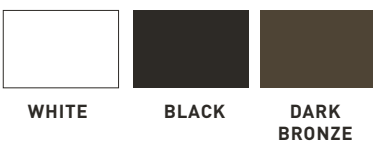

#### Classic

2.5" x 2.3"



#### Modern

2.25" x 1.8"



#### Drink Rail

2.7" x 5.5"

## 2. INFILLS

.75" x .56" Aluminum Rectangular



Aluminum Balusters Rectangular only

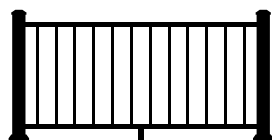

Aluminum Balusters With open mid-rail

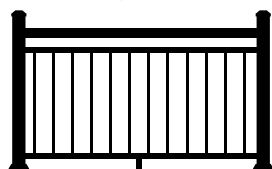

Glass Channel Kit Glass Not Included



Glass Channel Kit With open mid-rail



## 3. POSTS SLEEVES

2" x 2"  
3" x 3"



### For 3" Post Applications

3" x 3" Post



### For Over the Post Applications

2" x 2" Post



### For 4" Post Applications

4" x 4" Post Sleeve



## 3. CAPS AND SKIRTS

2" x 2" Cap  
2.36" x 2.36" Profile



2" x 2" Skirt  
3.88" x 3.88" Profile



3" x 3" Cap  
3.39" x 3.39" Profile



3" x 3" Skirt  
4.91" x 4.91" Profile



3" x 3" Cap  
3.39" x 3.39" Profile



3" x 3" Skirt  
5.38" x 5.38" Profile



2" x 2" Skirt  
3.88" x 3.88" Profile



4" x 4" Cap  
4.4" x 4.4" Profile



4" x 4" Skirt  
5.38" x 5.38" Profile



## 3. LIGHTING

3" x 3" Indirect Light Post Cap



3" x 3" Perimeter Light Post Cap







## Composite ADA Handrail

- ADA-compliant Handrail system that has aluminum reinforcement that reduces bowing and provides enduring strength
- Adjustable joiners to accommodate any transition
- Installs easily with no special tools required

### Color Options



WHITE



BLACK

PRODUCT DESCRIPTION	TimberTech Model Number	
	WHITE	BLACK
<b>COMPOSITE ADA HANDRAIL</b>		
ADA 104" Grab Rail	AZTADA104RSAW	AZTADA104RSAB
ADA 90° Corner with Joiners	AZTADA90DCWJW	AZTADA90DCWJB
ADA 90° Inside Corner Bracket	AZTADA90DICBW	AZTADA90DICBB
ADA Grab Rail End Cap - 4/Pkg	AZTADARECW	AZTADARECB
ADA Hand Rail Bracket Kit	AZTADAHRBKW	AZTADAHRBKB
ADA Handicap Loop	AZTADAHLW	AZTADAHLB
ADA Joint Ring - 4/Pkg	AZTADAJRW	AZTADAJRB
ADA Post Return	AZTADAPRW	AZTADAPRB
ADA Rail End Cap - 4/Pkg	AZTADARECW	AZTADARECB
ADA Straight Wall Return Kit	AZTADASWRKW	AZTADASWRKB
ADA Wall Return Cover Plate - 4/Pkg	AZTADAWRCPW	AZTADAWRCPB
ADA Wall Return with Joiner, Cover, and Plate	AZTADAWRCPWJW	AZTADAWRCPWJB
ADA External Adjustable Joiner	AZTADAEAJW	AZTADAEAJB
	TimberTech Model Number	
ADA Straight Joiner - 4/Pkg	AZTADASJ	
ADA Adjustable Joiner - 4/Pkg	AZTADAAJ	

## Metal ADA Handrail

- ADA-Compliant system is powder coated aluminum and passes codes for guard rail loads.
- Adjustable joiners to accommodate any transition
- Installs easily with no special tools required

PRODUCT DESCRIPTION	TimberTech Model Number		
	WHITE	BLACK	DARK BRONZE
<b>ADA HANDRAIL FOR IMPRESSION RAIL EXPRESS®</b> - Kits include all the components for the most common ADA Handrail applications. Combine kits for a custom application.			
<b>Aluminum ADA Pipe Rail and 90° Return Kit Black</b> (2- Wall Return Brackets, 1.5" x 94" aluminum railing; 2 backer plates, hardware, Rings and Covers)	AZTIXADAPR90DRKW	AZTIXADAPR90DRKB	AZTIXADAPR90DRKBR
<b>Aluminum ADA Pipe Rail Extension Kit</b> (2- Support Brackets, 1.5" x 94" aluminum railing; 2 backer plates, hardware, connectors and covers)	AZTIXADAPREKW	AZTIXADAPREKB	AZTIXADAPREKBR
<b>Aluminum ADA Handicap Loop Kit</b> (2- "D" Loops, 1- support Brackets; 2 adjustable joiners, 2 backer plates, hardware, connectors and covers)	AZTIXADAHLKW	AZTIXADAHLKB	AZTIXADAHLKBR
<b>Aluminum ADA 90° Wall Return Kit</b> (2 Wall Return Brackets, Hardware, Rings, Covers and backer plates)	AZTIXADA90DRKW	AZTIXADA90DRKB	AZTIXADA90DRKBR
Aluminum ADA Support Bracket - 1 Support Bracket & Hardware	AZTIXADAMSBW	AZTIXADAMSB	AZTIXADAMSBBR
Aluminum ADA Adjustable Elbow	AZTIXADAADJW	AZTIXADAADJB	AZTIXADAADJBR
Aluminum ADA 90 Degree Wall Return, Hardware and Ring Cover	AZTIXADA90WRW	AZTIXADA90WRB	AZTIXADA90WRBR
Aluminum ADA Handrail Pipes 1.5" x 94"	AZTIXADA94RW	AZTIXADA94RB	AZTIXADA94RBR

### Color Options



WHITE



BLACK



DARK BRONZE





## Secure Mount Post

- Allows railing installations without a wood post
- Can be installed on wood decks and concrete surfaces

PRODUCT DESCRIPTION	TimberTech Model Number
<b>SECURE MOUNT POST</b>	
4" Secure Mount Post	AZTSMP3642
6" Secure Mount Post Adapter	AZTSMP6ADAPT0R
Deck Mounting Kit	AZTSMPDMK



## TIMBERTECH® LIGHTING

Add the finishing touches to your deck and railing project with quality lighting options. Our lighting radiates sophistication and quality—an elegant enhancement to an already beautiful space.



## Universal Gate Kit

- A composite gate kit compatible with the Classic Composite Series
- Does not include top rail, bottom rail, or balusters
- Maximum width opening is 48"

PRODUCT DESCRIPTION	TimberTech Model Number		
	WHITE	BLACK	MATTE WHITE
<b>UNIVERSAL GATE KIT - For use with Classic Composite Series</b> Includes Hinges and Latch and side supports to convert Classic Composite Rail Pack or Kit to a gate (Railing and balusters sold separately)			
36" Universal Gate Kit	AZTGATEW	AZTGATEB	AZTGATEMW

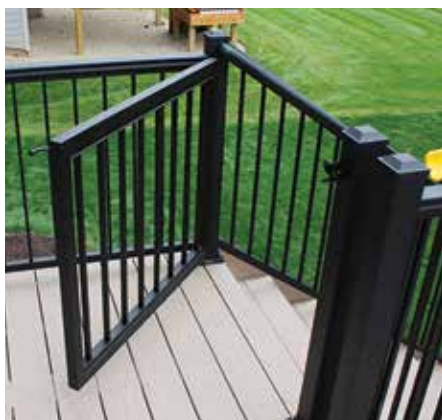
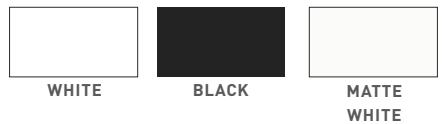

## Impression Rail Express® Gate Kit

- For 36" or 42" rail heights
- Available in White, Black, or Dark Bronze

PRODUCT DESCRIPTION	TimberTech Model Number		
	WHITE	BLACK	DARK BRONZE
<b>IMPRESSION RAIL EXPRESS GATE KIT - Kit includes Panel, Top &amp; Bottom Channel Covers, Latch and Hinge Kit (for up to 50" openings)</b>			
36" IRX Gate Kit	AZTIXGATE36W	AZTIXGATE36B	AZTIXGATE36BR
42" IRX Gate Kit	AZTIXGATE42W	AZTIXGATE42B	AZTIXGATE42BR



## Deck Lighting

PRODUCT DESCRIPTION	TimberTech Model Number
<b>DECK LIGHTING</b>	
LED In-Deck Light - Architectural Bronze - 4/Pkg	AZTDLLEDINDECKG2
LED Riser Light - Architectural Bronze	AZTDLLEDRISERB
LED Riser Light - White	AZTDLLEDRISERW
100w Transformer for LED Lighting (12 volt)	AZTDL100TRAN
16/2 100' wire for LED Lighting	AZTDLLEDWIRE
150W PowerPack/Dimmer	AZTDL150PP



IN-DECK LIGHT RISER LIGHT

## Composite Rail Lighting

PRODUCT DESCRIPTION	TimberTech Model Number
<b>COMPOSITE RAIL LIGHTING</b>	
4" x 4" LED Post Cap Light	TDL4X4CAPMOD
5" x 5" LED Post Cap Light	TDL5X5CAPMOD
5 1/2" x 5 1/2" LED Post Cap Light	ADL55X55CAPMOD
5 1/2" x 5 1/2" LED Lighted Island Cap - Black	ADL55X55ICAPMODB
5 1/2" x 5 1/2" LED Lighted Island Cap - White	ADL55X55ICAPMODW
5 1/2" x 5 1/2" LED Lighted Island Cap - Matte White	ADL55X55ICAPMODMW
5 1/2" x 5 1/2" LED Lighted Island Cap - Matte Black	ADL55X55ICAPMODMB
5 1/2" x 5 1/2" LED Lighted Island Cap - Matte Espresso	ADL55X55ICAPMODME
LED Accent Light - Architectural Bronze	AZTDLLEDACCB
LED Accent Light - White	AZTDLLEDACCW
LED Accent Light - Matte White	AZTDLLEDACCMW
LED Under Rail Light - 4/Pkg	AZTDLLEDURAIL



POST CAP LIGHT LIGHTED ISLAND CAP



ACCENT LIGHT UNDER RAIL LIGHT

## Impression Rail Express® Lighting

PRODUCT DESCRIPTION	TimberTech Model Number
<b>IMPRESSION RAIL EXPRESS® LIGHTING</b>	
3" x 3" Perimeter Light Post Cap - Black	AZTIXLIGPCB
3" x 3" Perimeter Light Post Cap - White	AZTIXLIGPCW
3" x 3" Perimeter Light Post Cap - Dark Bronze	AZTIXLIGPCBR
3" x 3" Indirect/Concealed Down Light Post Cap - Black	AZTIXLIGDCB
3" x 3" Indirect/Concealed Down Light Post Cap - White	AZTIXLIGDCW
3" x 3" Indirect/Concealed Down Light Post Cap - Dark Bronze	AZTIXLIGDCBR



INDIRECT LIGHT POST CAP PERIMETER LIGHT POST CAP





**TIMBERTECH® PAVERS**

Made from up to 95% recycled materials, TimberTech Pavers are high-performance, composite alternatives to stone that boast a natural appearance while resisting stains, scratches, and cracking for years to come. One-third the weight of traditional stone, TimberTech Pavers are ideal for resurfacing patios, balconies, and rooftops.



Photo: Boardwalk and Olive Resurfacing Pavers



**TIMBERTECH® DRYSPACE™**

Ideal for second-story decks, this sleek system collects and channels moisture so homeowners can make the most of the space below. Attach the system to new or existing deck joists and let this extruded vinyl system double your livable outdoor living spaces.



Photo: DrySpace in White

**Color Options**



REDWOOD



BOARDWALK



WATERWHEEL



OLIVE

PRODUCT DESCRIPTION	TimberTech Model Number			
	REDWOOD	BOARDWALK	WATERWHEEL	OLIVE
<b>RESURFACING PAVERS</b>				
4" x 8" Resurfacing Pavers 8 Pavers for 1 Dimpled Grid	K048-001	K048-002	K048-005	K048-007
8" x 8" Resurfacing Pavers 4 Pavers for 1 Dimpled Grid	K088-001	K088-002	K088-005	K088-007

PRODUCT DESCRIPTION	TimberTech Model Number			
	REDWOOD	BOARDWALK	WATERWHEEL	OLIVE
<b>ACCESSORY PAVERS</b>				
4" Bullnose Pavers - 36 Pavers Installation Grids must be purchased separately for use with Bullnose Pavers	A448-001	A448-002	A448-005	A448-007

PRODUCT DESCRIPTION	TimberTech Model Number
<b>INSTALLATION GRIDS</b>	
Dimpled Grid (16" x 16") Compatible with Resurfacing Pavers	SG51-001

PRODUCT DESCRIPTION	TimberTech Model Number
<b>DRAINAGE MATS</b>	
EnkaDrain 3801 Drainage Mat (4' x 50' x 0.3")	ENKA3801

**Color Options**



PRODUCT DESCRIPTION	TimberTech Model Number			
	12" BONE	16" BONE	12" WHITE	16" WHITE
<b>DRYSPACE</b>				
Combo Brackets	DSCOMB012B	DSCOMB016B	DSCOMB012W	DSCOMB016W
Double Combo Brackets	—	DSDBLCOMB016B	—	DSDBLCOMB016W
12" Panel Only	DS12PANEL12B	DS12PANEL16B	DS12PANEL12W	DS12PANEL16W
16" Panel Only	DS16PANEL12B	DS16PANEL16B	DS16PANEL12W	DS16PANEL16W
Ledger Bracket	DSFBACKET12B	—	DSFBACKET12W	—
12" O.C. DrySpace Kit	DS12KIT12B	—	DS12KIT12W	—
16" O.C. DrySpace Kit	DS16KIT12B	DS16KIT16B	DS16KIT12W	DS16KIT16W



V-PANEL

SINGLE COMBO BRACKET

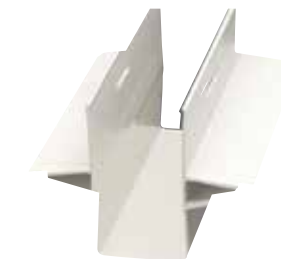

LEDGER F BRACKET

DOUBLE COMBO BRACKET





**AZEK**<sup>®</sup>  
Exteriors

#1 in Performance Trim











## AZEK® Trim with PaintPro® Technology

No primer needed. Get work finished faster thanks to quicker drying time. PaintPro can be handled 30 minutes after painting. AZEK Trim with PaintPro technology has all the benefits of AZEK Classic Trim including being virtually impervious to moisture, but also adds the benefit of a superior paint bond that enhances long-term performance.

## Classic AZEK Sheet

Applications over 16" wide are easy with Classic AZEK Sheet. Ideal for use in bay windows, dormers and raised panels.

## PaintPro Sheet

Applications over 16" wide are easy with AZEK PaintPro Sheet. Ideal for use in bay windows, dormers, and raised panels.

		AZEK Model Number		
		12'	18'	20'
<b>5/4 TRIMBOARD, 1" THICKNESS</b>				
Nominal	Actual			
5/4 x 4	1" x 3-1/2" Trimboard Smooth	AT12504144	AT12504216	AT12504240
5/4 x 4	1" x 3-1/2" Trimboard Woodgrain	AF12504144	AF12504216	AFT12504240
5/4 x 5	1" x 4-1/2" Trimboard Smooth	AT12505144	AT12505216	AT12505240
5/4 x 5	1" x 4-1/2" Trimboard Woodgrain	AF12505144	AF12505216	AF12505240
5/4 x 6	1" x 5-1/2" Trimboard Smooth	AT12506144	AT12506216	AT12506240
5/4 x 6	1" x 5-1/2" Trimboard Woodgrain	AF12506144	AF12506216	AF12506240
5/4 x 8	1" x 7-1/4" Trimboard Smooth	AT12508144	AT12508216	AT12508240
5/4 x 8	1" x 7-1/4" Trimboard Woodgrain	AF12508144	AF12508216	AF12508240
5/4 x 10	1" x 9-1/4" Trimboard Smooth	AT12510144	AT12510216	AT12510240
5/4 x 10	1" x 9-1/4" Trimboard Woodgrain	AF12510144	AF12510216	AF12510240
5/4 x 12	1" x 11-1/4" Trimboard Smooth	AT12512144	AT12512216	AT12512240
5/4 x 12	1" x 11-1/4" Trimboard Woodgrain	AF12512144	AF12512216	AF12512240
5/4 x 16	1" x 15-1/4" Trimboard Smooth	AT12516144	AT12516216	AT12516240
5/4 x 16	1" x 15-1/4" Trimboard Woodgrain	AF12516144	AF12516216	AF12516240

		AZEK Model Number		
		12'	18'	20'
<b>6/4 TRIMBOARD, 1-1/4" THICKNESS - 18' are Smooth Finish and 20' are Woodgrain Finish</b>				
Nominal	Actual		<b>Smooth</b>	<b>Woodgrain</b>
6/4 x 4	1-1/4" x 3-1/2" Trimboard	—	AT15004216*	AF15004240
6/4 x 6	1-1/4" x 5-1/2" Trimboard	—	AT15006216*	AF15006240
6/4 x 8	1-1/4" x 7-1/4" Trimboard	—	AT15008216*	AF15008240
6/4 x 10	1-1/4" x 9-1/4" Trimboard	—	AT15010216*	AF15010240
6/4 x 12	1-1/4" x 11-1/4" Trimboard	—	—	AF15012240

\*Indicates special order items with a six week lead time

		AZEK Model Number		
		12'	16'	20'
<b>PAINTPRO® TRIM Two-Sided, Reversible Finish: Smooth and Woodgrain</b>				
Nominal	Actual			
4/4 x 2	3/4" x 1-1/2"	—	AF10002192PP	—
4/4 x 3	3/4" x 2-1/2"	—	AF10003192PP	—
4/4 x 4	3/4" x 3-1/2"	—	AF10004192PP	—
4/4 x 6	3/4" x 5-1/2"	—	AF10006192PP	—
4/4 x 8	3/4" x 7-1/4"	—	AF10008192PP	—
4/4 x 10	3/4" x 9-1/4"	—	AF10010192PP	—
4/4 x 12	3/4" x 11-1/4"	—	AF10012192PP	—
5/4 x 4	1" x 3-1/2"	—	AF12504192PP	—
5/4 x 6	1" x 5-1/2"	—	AF12506192PP	—
5/4 x 8	1" x 7-1/4"	—	AF12508192PP	—
5/4 x 10	1" x 9-1/4"	—	AF12510192PP	—
5/4 x 12	1" x 11-1/4"	—	AF12512192PP	—

		AZEK Model Number				
		8'	10'	12'	18'	20'
<b>CLASSIC AZEK SHEET</b>						
Actual						
3/8" x 4' Sheet Smooth	AS03848096	AS03848120	AS03848144	AS03848216	—	—
3/8" x 4' Sheet Woodgrain	ASF03848096	ASF03848120	—	—	—	—
1/2" x 4' Sheet Smooth	AS01248096	AS01248120	AS01248144	AS01248216	—	—
1/2" x 4' Sheet Woodgrain	ASF01248096	ASF01248120	—	—	—	—
5/8" x 4' Sheet Smooth	AS05848096	AS05848120	AS05848144	AS05848216	—	—
3/4" x 4' Sheet Smooth	AS03448096	AS03448120	AS03448144	AS03448216	—	—
3/4" x 4' Sheet Woodgrain	ASF03448096	ASF03448120	—	—	—	—
1" x 4' Sheet Smooth	AS10048096	AS10048120	AS10048144	AS10048216	AS10048240	—

		AZEK Model Number			
		8'	10'	12'	20'
<b>PAINTPRO® SHEET Two-Sided, Reversible Finish: Smooth and Woodgrain</b>					
Actual					
3/4" x 4'	ASF03448096PP	ASF03448120PP	—	—	—
1/2" x 4'	ASF01248096PP	ASF01248120PP	ASF01248144PP	—	—

		AZEK Model Number				
		8'	10'	12'	18'	20'
<b>AZEK TO MILL</b>						
Actual						
1 1/4" x 9 1/4" ATM Board Smooth	—	—	—	—	AT15010216	—
1-1/2" x 3-1/2" ATM Board Smooth	—	—	—	—	AT20004216	—
1-1/2" x 5-1/2" ATM Board Smooth	—	—	—	—	AT20006216	—
1-1/2" x 7-1/4" ATM Board Smooth	—	—	—	—	AT20008216	—
1-1/2" x 9-1/4" ATM Board Smooth	—	—	—	—	AT20010216	—
1-1/2" x 11-1/4" ATM Board Smooth	—	—	—	—	AT20012216	—

		AZEK Model Number				
		8'	10'	12'	18'	20'
<b>AZEK TO MILL (ATM)</b>						
Actual						
1-1/4" x 4' ATM Sheet Smooth	AS11448096	—	—	—	—	—
1-1/2" x 4' ATM Sheet Smooth	AS11248096	AS11248120	AS11248144	—	—	AS11248240

		AZEK Model Number		
		12'	18'	20'
<b>RABBETED TRIM</b>				
Nominal	Actual			
5/4 x 4	1" x 3-1/2" Smooth	—	ATR12504216	—
5/4 x 4	1" x 3-1/2" Woodgrain	—	AFR12504216	—
5/4 x 6	1" x 5-1/2" Smooth	—	ATR12506216	—
5/4 x 6	1" x 5-1/2" Woodgrain	—	AFR12506216	—
5/4 x 8	1" x 7-1/4" Smooth	—	ATR12508216	—
5/4 x 8	1" x 7-1/4" Woodgrain	—	AFR12508216	—

		AZEK Model Number		
		12'	18'	20'
<b>FLANGE SLOTTED WINDOW TRIM</b>				
Nominal	Actual			
5/4 x 4	Slotted - Smooth	—	ATS12504216	—
5/4 x 4	Slotted - Woodgrain	—	AFS12504216	—
5/4 x 4	Slotted & Rabbeted - Smooth	—	ATSR12504216	—
5/4 x 4	Slotted & Rabbeted - Woodgrain	—	AFSR12504216	—
5/4 x 6	Slotted - Smooth	—	ATS12506216	—
5/4 x 6	Slotted - Woodgrain	—	AFS12506216	—
5/4 x 6	Slotted & Rabbeted - Smooth	—	ATSR12506216	—
5/4 x 6	Slotted & Rabbeted - Woodgrain	—	AFSR12506216	—

		AZEK Model Number				
		8'	10'	12'	18'	20'
<b>CORNERBOARDS</b>						
Nominal	Actual					
5/4 x 4" x 4"	1" x 3-1/2" Cornerboard Smooth	—	AMT04120C	—	—	AMT04240C
5/4 x 4" x 4"	1" x 3-1/2" Cornerboard Woodgrain	—	AMF04120C	—	—	AMF04240C
5/4 x 6" x 6"	1" x 5-1/2" Cornerboard Smooth	—	AMT06120C	—	—	AMT06240C
5/4 x 6" x 6"	1" x 5-1/2" Cornerboard Woodgrain	—	AMF06120C	—	—	AMF06240C
5/4 x 8" x 8"	1" x 7 1/4" Cornerboard Smooth	—	—	—	—	AMT08240C

		AZEK Model Number				
		8'	10'	12'	18'	20'
<b>RABBETED CORNERBOARDS</b>						
Nominal	Actual					
5/4 x 4" x 4"	1" x 3-1/2" Rabbeted - Smooth	—	AMTR04120C	—	—	AMTR04240C
5/4 x 4" x 4"	1" x 3-1/2" Rabbeted - Woodgrain	—	AMFR04120C	—	—	AMFR04240C
5/4 x 6" x 6"	1" x 5-1/2" Rabbeted - Smooth	—	AMTR06120C	—	—	AMTR06240C
5/4 x 6" x 6"	1" x 5-1/2" Rabbeted - Woodgrain	—	AMFR06120C	—	—	AMFR06240C
5/4 x 8" x 8"	1" x 7-1/4" Rabbeted - Smooth	—	—	—	—	AMTR08240C

## AZEK® to Mill (ATM)

ATM's thick profile makes it an ideal material for fabrication. Its consistent density offers a superior product for milling operations.



## Rabbeted Trim

With rabbeted edges, this one-piece trimboard is designed to ease siding installation and deliver a crisp facade.

## Flange Slotted Trim

Typical window trims installed over a window nailing fin need to be shimmed or pulled back for the trim to lay flat. Flange Slotted Window Trim does not and is engineered to create consistent long-lasting window surrounds by removing the installation challenges created by windows installed with a nailing fin.

## Cornerboards

With dirt-free seams that will not open, AZEK® Cornerboards offer faster and more aesthetically pleasing installations to complement any home exterior.

## Rabbeted Cornerboards

With rabbeted edges, this one-piece cornerboard is designed to make siding installations a breeze and help deliver a crisp facade with smooth outside edges and dirt-free seams.

## Quick Corner®

The inner and outer quick corners are installed with hidden fasteners, completely eliminating the need for excessive face nailing and touch-up. It is also versatile enough to be used with multiple types of sidings.

AZEK Model Number		8'	10'	12'	18'	20'
<b>QUICK CORNER® OUTSIDE CORNER</b>						
Nominal	Actual					
5/4 x 4" x 4"	1" x 3-1/2" x 3-1/2" with J-Channel	—	—	—	—	AMT04240JC
5/4 x 6" x 6"	1" x 5-1/2" x 5-1/2" with J-Channel	—	—	—	—	AMT06240JC
AZEK Model Number		8'	10'	12'	18'	20'
<b>QUICK CORNER® INSIDE CORNER</b>						
Nominal	Actual					
3/8 x 3 x 3	3/8" x 2-1/2" x 2-1/2" with J-Channel	—	—	—	—	AMJCIC03240

## J-Casing

J-Casing offers the most beautiful and seamless transition between your siding and trim. Engineered to reduce labor and save costs by eliminating paint and extra j-channel installs.

AZEK Model Number		8'	10'	12'	16'	18'	20'
<b>J-CASING</b>							
Nominal	Actual						
1 x 4	1-1/8 x 3-1/2" J-Casing	—	—	—	AMFC04192JCB	AMFC04216JCB	—
1 x 6	1-1/8 x 5-1/2" J-Casing	—	—	AMFC06144JCB	—	—	—
-	1-1/4 x 2" Brick Mould	—	—	—	—	AMBM02216JCB	—

## Universal Skirt Board

A two-piece skirt board with a two-sided trimboard (one side in Smooth, the other in Woodgrain) designed to assist with water management. Routed with a universal siding interface. Installation is quick and easy.

AZEK Model Number		8'	10'	12'	18'	20'
<b>UNIVERSAL SKIRT BOARD</b>						
Nominal	Actual					
5/4 x 6"	1" x 5-1/2" Universal Skirt Board - Woodgrain	—	—	—	AFUS07216	—
5/4 x 8"	1" x 7-1/4" Universal Skirt Board - Woodgrain	—	—	—	AFUS09216	—
5/4 x 10"	1" x 9-1/4" Universal Skirt Board - Woodgrain	—	—	—	AFUS11216	—
5/4 x 12"	1" x 11 1/4" Universal Skirt Board - Woodgrain	—	—	—	AFUS12216	—

## One-Piece Skirt Board

One-Piece Skirt Board is designed to eliminate purchasing and installing a separate starter strip, skirt board and flashing while helping drain water away from the main structure. Save time and cost without compromising aesthetics.

AZEK Model Number		8'	10'	12'	18'	20'
<b>ONE-PIECE SKIRT BOARD</b>						
Nominal	Actual					
4/4 x 8"	3/4" x 7-1/4" One-Piece Skirt Board - Smooth	—	—	—	ATSB10008216	—
4/4 x 8"	3/4" x 7-1/4" One-Piece Skirt Board - Woodgrain	—	—	—	AFSB10008216	—
4/4 x 10"	3/4" x 9-1/4" One-Piece Skirt Board - Smooth	—	—	—	ATSB10010216	—
4/4 x 10"	3/4" x 9-1/4" One-Piece Skirt Board - Woodgrain	—	—	—	AFSB10010216	—
5/4 x 6"	1" x 5-1/2" One-Piece Skirt Board - Smooth	—	—	—	ATSB12506216	—
5/4 x 6"	1" x 5-1/2" One-Piece Skirt Board - Woodgrain	—	—	—	AFSB12506216	—
5/4 x 8"	1" x 7-1/4" One-Piece Skirt Board - Smooth	—	—	—	ATSB12508216	—
5/4 x 8"	1" x 7-1/4" One-Piece Skirt Board - Woodgrain	—	—	—	AFSB12508216	—
5/4 x 10"	1" x 9-1/4" One-Piece Skirt Board - Smooth	—	—	—	ATSB12510216	—
5/4 x 10"	1" x 9-1/4" One-Piece Skirt Board - Woodgrain	—	—	—	AFSB12510216	—

## Integrated Drip Edge

Designed to assist with water management efforts around doors and windows. Comes in two pieces with a two-sided trimboard; one side in Smooth and the other in Woodgrain. Easy to install, the drip edge has an integrated nailing flange to reduce installation time and costs.

AZEK Model Number		8'	10'	12'	18'	20'
<b>INTEGRATED DRIP EDGE</b>						
Nominal	Actual					
5/4 x 4"	1" x 3-1/2" Integrated Drip Edge	—	—	—	AFWB05216	—
5/4 x 6"	1" x 5-1/2" Integrated Drip Edge	—	—	—	AFWB07216	—
5/4 x 8"	1" x 7-1/4" Integrated Drip Edge	—	—	—	AFWB09216	—

AZEK Model Number		8'	10'	12'	18'	20'
<b>BEADBOARD, SMOOTH FINISH</b>						
Actual						
3/4" x 5-1/2" Beadboard E & CB		—	—	—	AM1006216ECB	—
1/2" x 3 1/2" Beadboard E & CB		—	—	—	AM01204216ECB	—
1" x 4" Beadboard E & CB		—	—	—	AM1004216ECB	—
5/8" x 3-1/2" Beadboard		—	—	—	AM0620418	—
1/2" x 5-1/2" Beadboard		—	—	—	AM0120618F	—
1/2" x 4' x 8' Beadboard Sheet E & CB	AS01248096ECB					

AZEK Model Number		8'	10'	12'	18'	20'
<b>TONGUE AND GROOVE</b>						
Actual						
3/4" x 5-1/2" WP4/Nickel Gap		—	—	—	AM1006216WPN	—
3/4" x 5-1/2" Tongue & Groove Shiplap		—	—	—	AM10006216TGS	—
3/4" x 7-1/4" Tongue & Groove Shiplap		—	—	—	AM10008216TGS	—

AZEK Model Number		8'6"	10'
<b>AZEK 3-PLUS-1 COLUMN WRAP</b>			
Nominal	Inside Dimension	Outside Dimension	
4 x 4	3-3/4" x 3-3/4"	4-3/4" x 4-3/4"	ATCW0404096.6 ATCW0404120
6 x 6	5-3/4" x 5-3/4"	6-3/4" x 6-3/4"	ATCW0606096.6 ATCW0606120
8 x 8	7-3/4" x 7-3/4"	8-3/4" x 8-3/4"	ATCW0808096.6 ATCW0808120

4"		6"
<b>COLUMN KITS AND ACCESSORIES (for 3-Plus-1 Column Wraps only)</b>		
Description		
TRIM KIT - BASE MLDG	ACW4"TRIMKITBASE	ACW6"TRIMKITBASE
TRIM KIT - BED MLDG	ACW4"TRIMKITBED	ACW6"TRIMKITBED
TRIM KIT - BED MLDG XL*	ACW4"TRIMKITBEDXL	ACW6"TRIMKITBEDXL
TRIM KIT - CROWN MLDG	ACW4"TRIMKITCROWN	ACW6"TRIMKITCROWN
TRIM KIT - CROWN MLDG XL*	ACW4"TRIMKITCROWNXL	ACW6"TRIMKITCROWNXL
ACCENT WRAP 10"	ACWAW040410	ACWAW060610

\*: for use with Accent Wraps.

AZEK Model Number		5'	6'
<b>TAPERED COLUMN WRAP</b>			
Actual			
12" base / 8" cap x 5' Tapered Column Wrap		ATCWT1208060	ATCWT1208072
16" base / 12" cap x 6' Tapered Column Wrap		ATCWT1612060	ATCWT1612072

AZEK Model Number		12'	18'	20'
<b>SOFFIT SYSTEM</b>				
Nominal	Actual			
1/2 x 12	1/2" x 12" Vented Soffit	—	ATVS01212216	—
1/2 x 16	1/2" x 16" Vented Soffit	—	ATVS01216216	—
1/2 x 12	1/2" x 12" Solid Soffit	—	ATSS01212216	—
1/2 x 16	1/2" x 16" Solid Soffit	—	ATSS01216216	—
1 x 8	3/4" x 7-1/4" Notched Fascia	—	AT10008216NF	—
5/4 x 6	5/4 x 6 Frieze Board	—	AT12508216FB	—

## Beadboard

AZEK Beadboard is reversible with an edge and center bead on one side and a v-groove on the other. AZEK Beadboard (E & CB) is certified UL580 class 90 wind gust uplift-resistant, making it ideal for use in coastal areas.

## Nickel Gap and Shiplap

AZEK Tongue and Groove profiles, available in shiplap and reversible WP4/nickel gap form factors, offer enhanced design and installation flexibility.

## Columns

AZEK's Column Wrap profile allows for easy one-person installation, saving time and costs. Three connected panels and a fourth "locking" panel fit easily around a structural support with press fit seams and smooth, finished corners. AZEK Column Wrap is available in semi-matte white Smooth finish.

## Soffit System

Available in two profiles, Solid and Vented. Both provide climate-resistant material for smooth, beautiful finishing to match any home exterior. Add the notched fascia and frieze board and you have an efficient, easy-to-install system.





# MOULDING

CREATE STUNNING DETAILS THAT LAST. Backed by AZEK's promise of high-quality and lasting performance, AZEK Moulding will retain a like-new appearance despite the tests of time and weather. With over 30 different profiles to mix and match, you can customize any build with a distinctive look.



## Crown Profiles

Use AZEK Crown Moulding as decorative accents along the intersection of a wall and ceiling or choose a combination of profiles to create an elegantly custom look.

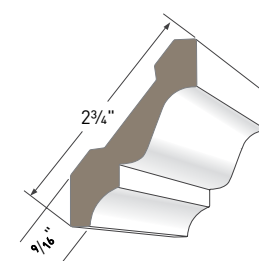

**3" CROWN**  
AZM-52  
Length: 16'

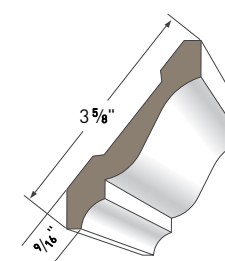

**4" CROWN**  
AZM-49  
Length: 16'

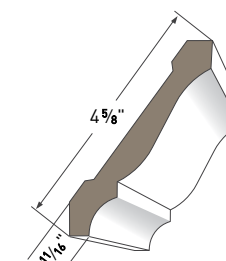

**5" CROWN**  
AZM-47  
Length: 16'

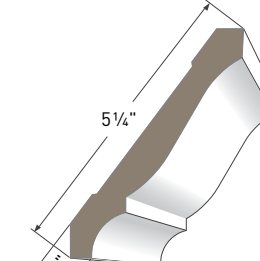

**6" CROWN**  
AZM-45  
Length: 16'

## Detail and Sill/Drip Profiles

The AZEK Drip Cap can be used as a water table or brick ledge for separation and watershed against two different materials. AZEK's Sill profiles shed water and offer architectural detail.

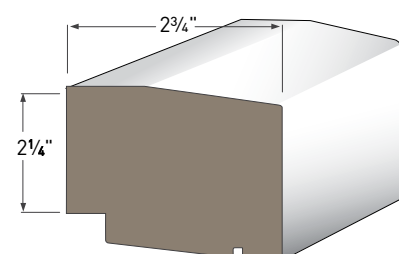

**FARMHOUSE SILL**  
AZM-7640  
Length: 16'

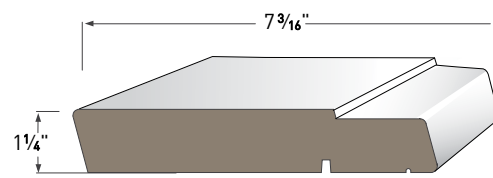

**DOUBLE HUNG SILL**  
AZM-7650  
Length: 18'

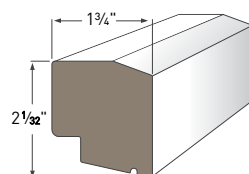

**HISTORIC SILL**  
AZM-6930  
Length: 16'

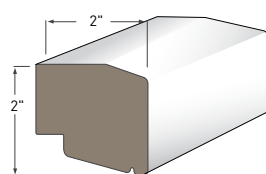

**LARGE SILL NOSE**  
AZM-7979  
Length: 16'

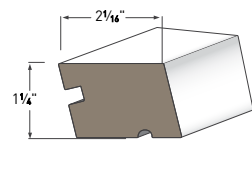

**WINDOW SILL NOSE**  
AZM-7974  
Length: 12'

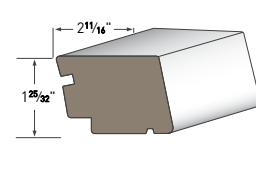

**LARGE HISTORIC SILL**  
AZM-7958  
Length: 16'

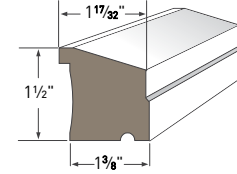

**SUB SILL NOSE**  
AZM-6933  
Length: 16'

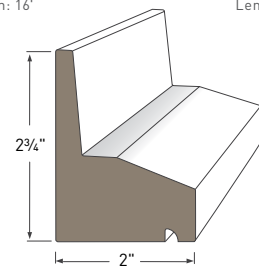

**WATER TABLE**  
AZM-6935  
Length: 18'

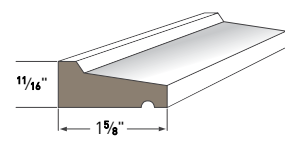

**DRIP CAP**  
AZM-197  
Length: 16'

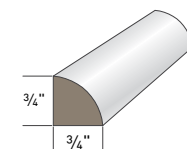

**QUARTER ROUND**  
AZM-105  
Length: 16'

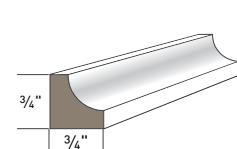

**SCOTIA**  
AZM-93  
Length: 16'

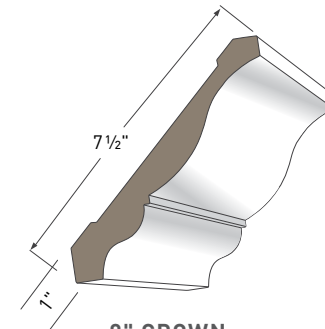

**8" CROWN**  
AZM-43  
Length: 16'

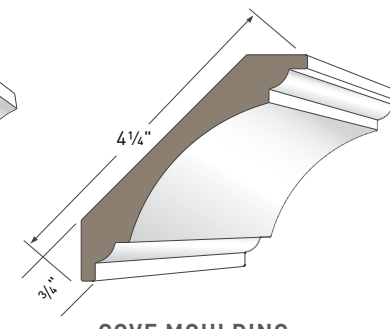

**COVE MOULDING**  
AZM-80  
Length: 16'

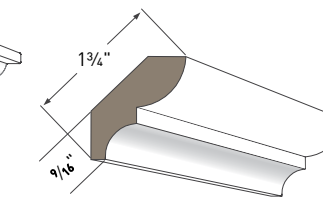

**BED MOULDING**  
AZM-75  
Length: 16'

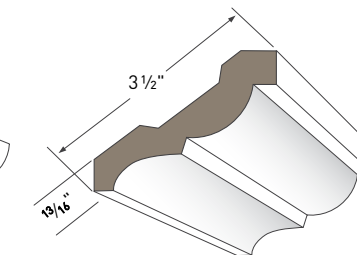

**3 1/2" BED MOULDING**  
AZM-28  
Length: 16'

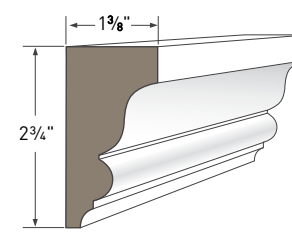

**IMPERIAL RAKE CROWN**  
AZM-6937  
Length: 16'

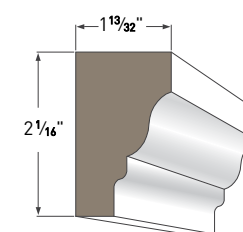

**RAMS CROWN**  
AZM-6934  
Length: 16'

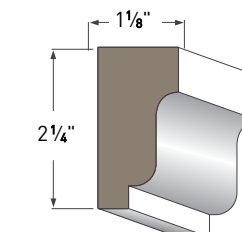

**SOLID CROWN**  
AZM-7954  
Length: 16'

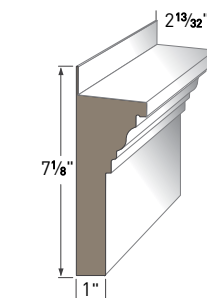

**CROSSHEAD PEDIMENT**  
AZM-6216  
Length: 18'



# Casing Profiles

Use AZEK® Casing profiles as decorative mouldings against a wall, door, or window to create surrounds. Complement windows and doors with a single profile or combine multiple profiles for a personalized exterior transformation.

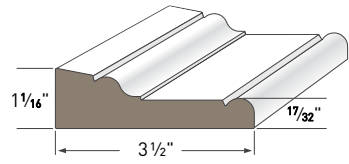

**ADAMS CASING AZM-97**  
Length: 16'

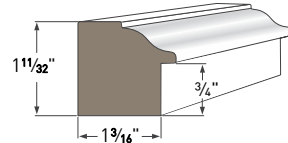

**BACK BAND AZM-6931**  
Length: 16'

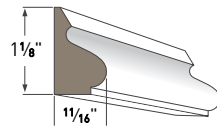

**BASE CAP AZM-164**  
Length: 16'

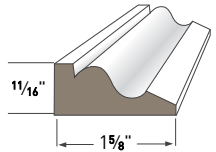

**BAND MOULDING AZM-217**  
Length: 16'

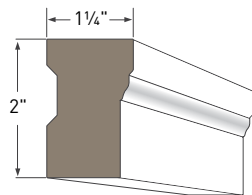

**BRICK MOULD AZM-180**  
Lengths: 16, 17' and 18'

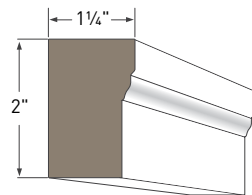

**FLATBACK BRICK MOULD AZM-7526**  
Lengths: 17'

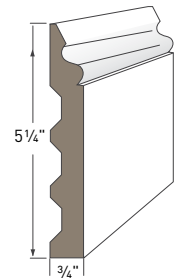

**COLONIAL BASE CAP AZM-163**  
Length: 16'

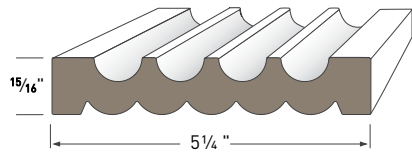

**FLUTED/REEDED AZM-606**  
Length: 16'

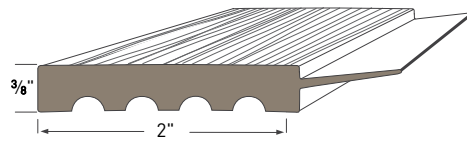

**GARAGE DOOR THERMOSTOP AZM-6936**  
Lengths: 7', 9', and 16'

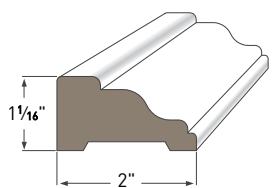

**RAKE MOULDING AZM-287**  
Length: 16'

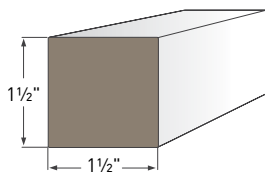

**SQUARE PROFILE AZM-236**  
Length: 12'

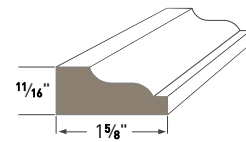

**SHINGLE MOULD AZM-210**  
Length: 16'

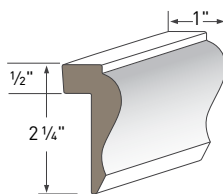

**WAINSCOT CAP AZM-284**  
Length: 16'

MOULDING	AZEK Model Number			
	12'	16'	17'	18'
Actual				
9/16" x 2-3/4" 3" Crown AZM-52	—	AMCM03192	—	—
9/16" x 3-5/8" 4" Crown AZM-49	—	AMCM04192	—	—
11/16" x 4-5/8" 5" Crown AZM-47	—	AMCM05192	—	—
11/16" x 5-1/4" 6" Crown AZM-45	—	AMCM06192	—	—
1" x 7-1/2" 8" Crown AZM-43	—	AMCM08192	—	—
3/4" x 4-1/4" Cove Moulding AZM-80	—	AMCC05192	—	—
1-13/32" x 2-1/16" Rams Crown AZM-6934	—	AMRC02192	—	—
1-3/8" x 2-3/4" Imperial/Rake Crown AZM-6937	—	AMIR03192	—	—
9/16" x 1-3/4" Bed Moulding AZM-75	—	AMBD02192	—	—
13/16" x 3-1/2" Bed Moulding AZM-28	—	AMBD04192	—	—
3/4" x 3/4" Scotia AZM-93	—	AMSC01192	—	—
3/4" x 3/4" Quarter Round AZM-105	—	AMQR01192	—	—
11/16" x 1-5/8" Shingle Mould AZM-210	—	AMSM02192	—	—
11/16" x 1-5/8" Band Moulding AZM-217	—	AMBN02192	—	—
1" x 2-1/4" Wainscot Cap AZM-284	—	AMWC03192	—	—
11/16" x 1-1/8" Base Cap AZM-164	—	AMBC02192	—	—
1-1/4" x 2" Brick Mould AZM-180	—	AMBM02192	AMBM02204	AMBM02216
1-1/4" x 2" Flatback Brick Mould AZM-7526	—	—	AMFBM02204	—
1-11/32" x 1-3/16" Back Band AZM-6931	—	AMBB02192	—	—
1-1/16" x 2" Rake Moulding AZM-287	—	AMRM02192	—	—
1-1/16" x 3-1/2" Adams Casing AZM-97	—	AMAC04192	—	—
3/4" x 5-1/4" Colonial Base Cap AZM-163	—	AMCB06192	—	—
15/16" x 5-1/4" Fluted/Reeded Casing AZM-606	—	AMFR06192	—	—
Crosshead Pediment AZM-6216	—	—	—	AMCP04216
1-1/2" x 1-1/2" Square AZM-236	AMIC02144	—	—	—
11/16" x 1-5/8" Drip Cap AZM-197	—	AMDC02192	—	—
2-3/4" x 2" Water Table AZM-6935	—	—	—	AMWT03216
1-3/4" x 2-1/32" Historic Sill AZM-6930	—	AMHS02192	—	—
1-17/32" x 1-1/2" x 1-3/8" Sub Sill Nose AZM-6933	—	AMSS02192	—	—
1-1/8" x 2-1/4" Solid Crown AZM-7954	—	AMCM02192CB	—	—
1-25/32" x 2-11/16" Large Historic Sill AZM-7958	—	AMHS03192CB	—	—
2" x 2" Large Sill Nose AZM-7979	—	AMLSN02192CB	—	—
1-1/4" x 2-1/16" Window Sill Nose AZM-7974	AMWSN02144CB	—	—	—

GARAGE DOOR THERMOSTOP AZM-6936	AZEK Model Number				
	7'	9'	12'	16'	18'
Actual					
3/8" x 2" Garage Door Thermostop AZM-6936	AMGT03084	AMGT03108	—	AMGT03192	—

### Industry Leading Warranties

With decades in the business partnered with dedicated investments to research and development, AZEK makes it our mission to provide the best materials on the market. We guarantee the integrity of our siding, cladding, trim and moulding with a lifetime limited warranty that covers rotting, splitting, splintering, peeling and warping. It is also easy to maintain and resistant to mold, mildew and moisture damage. For more information, visit [AZEKexteriors.com/warranty](http://AZEKexteriors.com/warranty).

### Contractor and Builder Information

AZEK® Siding, Cladding, Trim & Moulding should be installed using the same good building principles used to install wood trim and mouldings and in accordance with the local building codes and established installation guidelines. AZEK accepts no liability or responsibility for the improper installation of this product.

AZEK® Siding, Cladding, Trim & Moulding may not be suitable for every application and it is the sole responsibility of the installer to be sure that AZEK Siding, Cladding, Trim and Moulding are fit for the intended use. Since all installations are unique, it is also the installer's responsibility to determine specific requirements in regard to each application. AZEK recommends that all applications be reviewed by a licensed architect, engineer or local building official before installation.





## AZEK Shingle Siding with PaintPro® Technology

Made from a state-of-the-art proprietary engineered polymer, AZEK® Shingle matches the attractive texture of cedar shingles while adding the performance and low-maintenance benefits of rot-proof PVC building materials. Leveraging our innovative new PaintPro Technology, AZEK Shingle offers a rapid dry time, superior paint adhesion, and a painted finish that lasts without needing touch-ups or frequent maintenance.



### Straight Edge Shingle

Consistency with a dash of variety. Uniform horizontal lines with varied width tabs and key ways for the most natural-looking shingle to beautifully complement modern or classic exterior architecture.



### Staggered Edge Shingle

Patterns with individual character, dimension, and diversity. Each random edge panel enhances the overall pattern for an amazing exterior picture. Beautiful variety in both vertical and horizontal lines.

SHINGLE SIDING		
5" Reveal Straight Edge Shingle Panel	48" x 12" x 1/4"	ASSTRE02512048
7" Reveal Straight Edge Shingle Panel	48" x 16" x 1/4"	ASSTRE02516048
6" Reveal Staggered Edge Shingle Panel	48" x 15" x 1/4"	ASSTGE02515048



## Board and Batten

Both AZEK Sheet (board) and Trim Boards (batten strips) are made from moisture-resistant, premium cellular PVC engineered to endure. For a finished look that requires paint, use Sheet and Trim Boards enhanced with AZEK PaintPro Technology. If a timeless white board and batten look is desired, use AZEK Classic Sheet and Trim Boards that come in a semi-matte white finish and require no painting.

See full listing of trim board and sheet sizes on pages 43 and 44.



### AZEK BOARD AND BATTEN WITH PAINTPRO TECHNOLOGY

AZEK Model Number		
		16'
Batten Options (Trim Board)		
Nominal	Actual	
4/4 x 2	3/4" x 1-1/2"	AF10002192PP
4/4 x 3	3/4" x 2-1/2"	AF10003192PP

AZEK Model Number				
		8'	10'	12'
Board Options (Sheet)				
Actual				
1/2" x 4'	ASF01248096PP	ASF01248120PP	ASF01248144PP	

### AZEK BOARD AND BATTEN - CLASSIC WHITE

AZEK Model Number		
		18'
Batten Options (Trim Board)		
Nominal	Actual	
4/4 x 2	3/4" x 1-1/2" Reversible*	AF10002216
4/4 x 3	3/4" x 2-1/2" Smooth	AT10003216

AZEK Model Number			
		8'	10'
Board Options (Sheet)			
Actual			
1/2" x 4' Reversible*	ASF01248096	ASF01248120	

\* Reversible features woodgrain on one side and smooth on the other



## AZEK® Cladding

AZEK Capped Polymer Cladding offers a wide range of color options, multiple board widths and offers both tongue-and-groove (closed-joint) and square shoulder boards (open-joint).

See full listing of cladding plank colors and sizes listed within the TimberTech AZEK Vintage Collection® on pages 5 and 7.

### RESIDENTIAL WARRANTIES



### COMMERCIAL WARRANTIES



## Designed for Residential and Commercial

AZEK Capped Polymer Cladding is designed for commercial, residential and multi-family projects. Delivering the full aesthetic experience of premium hardwoods without the laborious, costly, and constant upkeep required with traditional lumber. Our one-of-a-kind capped polymer boards achieve a realistic hardwood look that lasts—that's why we back them with industry-leading fade and stain and product warranties for both commercial and residential buildings.







## Adhesive and Tools

Quickly, easily and securely bond AZEK trim to multiple surfaces with AZEK adhesives engineered specifically to bond with PVC products. Get a permanent solution for core-to-core bonding, surface bonding, sealing and filling PVC trim and moulding for an attractive finish.

	AZEK Model Number					
	4 OZ	8 OZ	16 OZ	32 OZ	128 OZ	640 OZ
<b>PVC CEMENT</b>						
Cellular PVC Cement	AAD0040Z	AAD0080Z	AAD0160Z	AAD0320Z	AAD1280Z	AAD6400Z

	AZEK Model Number					
	4 OZ	8 OZ	16 OZ	32 OZ	128 OZ	640 OZ
<b>PVC CEMENT SQUEEZE BOTTLE</b>						
Cellular PVC Cement	AADB0040Z	AADB0080Z				

	AZEK Model Number		
		50 ML	220 ML
<b>FAST CURE/SLOW CURE ADHESIVES &amp; TOOLS</b>			
Fast Cure Structural Starter Kit	Includes 2 mixers, 50 ml adhesive and caulk gun adapter	AAD50MLFCSK	—
Slow Cure Structural Starter Kit	Includes 2 mixers, 50 ml adhesive and caulk gun adapter	AAD50MLSCK	—
Fast Cure Structural Adhesive		AAD50MLFCS	AAD220MLMLFCS
Slow Cure Structural Adhesive		AAD50MLSCS	AAD220MLSCS
Qwik-Mixers		AAD50MLSQM	AAD220MLQM
Manual Dispense Gun		AAD50MLMG	AAD220MLHF
Fill & Flex Caulking Gun Adapter, 300 ml	AAD50MLCGA		

	AZEK Model Number
<b>ADHESIVE &amp; TOOLS</b>	
Fill & Flex, 300 ml	AAD300MLFF
Nail Eraser, 0.5 oz	AADNEBLIS
Plastic Joining Biscuits	AADPJB
AZEK Adhesive Opening Order SKU	AAD14P00S



### Fast Cure Adhesive

White, two-part acrylic-based adhesive ideal for bonding AZEK to AZEK products. Also bonds PVC to wood, metal, brick, vinyl, glass and other PVC. Work time 4-7 minutes at 70°F. Fully cures in 24 hours. Fills nail holes and gaps up to 1/8". Requires Qwik-Mixer for easy mixing and dispensing.



### Slow Cure Adhesive

White, two-part acrylic-based adhesive ideal for bonding AZEK to AZEK products. Also bonds PVC to wood, metal, brick, vinyl, glass and other PVC. Work time 15-25 minutes at 70°F. Fully cures in 24 hours. Fills nail holes and gaps up to 1/2". Requires Qwik-Mixer for easy mixing and dispensing.



### Cellular PVC Cement

Clear, contact-style adhesive bonds with PVC in a fast working time. Ideal for securing joints. Creates a powerful and reliable material bond with no sanding or scraping required. Use AZEK Cellular PVC Cement to connect trim when a tight compression is required, such as connecting trim end-to-end (scarf joints) and at corners (miter joints).



### Fill & Flex

Use for expansion and contraction joints on PVC trim boards. Seals gaps around windows and doors. Slow curing, one-part, urethane-based sealant with high level of flexibility and elongation to absorb expansion and contraction from heat or cold.

## Adhesive Accessories



**QWIK-MIXERS**  
50 ml: AAD50MLSQM,  
220 ml: AAD220MLQM

Required dispenser for Fast Cure and Slow Cure AZEK Adhesive products. The resin and catalyst blend together as they travel down the tube to the applicator tip. Ensures 1:1 ratio mix and provides easy adhesive application. 24 per pack.



**NAIL ERASER**  
Fills finish nail and brad holes in PVC trim board. Resists yellowing. .5oz



**MANUAL 220 ML DISPENSING GUN**  
Its 26:1 mechanical advantage dispenses high and low viscosity adhesives with less user fatigue. Designed to maximize durability.



**MANUAL 50 ML DISPENSING GUN**  
Made of highly engineered plastic to be lightweight and powerful. Easy loading breech provides secure cartridge fit.



**CAULKING GUN ADAPTER**  
Tool adapter for caulking guns.



**PLASTIC JOINING BISCUITS**  
Easy way to join, seal and finish PVC trim. 50 per pack





# CORTEX®

Save time, money, and labor costs with Cortex for AZEK® Trim. The only concealed fastening system that quickly and easily fastens AZEK Trim to your building project comes with collated strips to make fastening up to 50% faster. The felt tip on the unique bit prevents surface marring while driving fasteners securely below the trim surface. Plugs made of AZEK Trim tap in for a clean, flush finish. No mess and no fading over the life of the project. Plus, Cortex fasteners offer a stronger connection than nails.

## Cortex Benefits

- Fast and easy: eliminates the need to caulk, sand and paint each nail hole
- Plugs made out of same AZEK material as trim; eliminates fading or streaking
- Can be painted
- Guaranteed corrosion resistance for life of the project; ACQ approved



AZEK Model Number	
<b>CORTEX® PLUGS, NO SCREWS</b>	
Smooth Collated Cortex - 40 Plugs (no screws)	ATCTC40PC
Woodgrain Collated Cortex - 40 Plugs (no screws)	AFCTC40PC

	AZEK Model Number		
	50 LN FT	250 LN FT	750 LN FT
<b>SCREW, PLUG AND BIT KITS</b>			
Smooth Cortex 2" Screws	ATCTL50LF200	ATCTL250LF200	ATCTL750LF200
Smooth Collated Cortex 2" Screws	—	ATCTC250LF200	ATCTC750LF200
Smooth Cortex 2-3/4" Screws	ATCTL50LF275	ATCTL250LF275	ATCTL750LF275
Smooth Collated Cortex 2-3/4" Screws	—	ATCTC250LF275	ATCTC750LF275
Woodgrain Cortex 2" Screws	AFCTL50LF200	AFCTL250LF200	AFCTL750LF200
Woodgrain Collated Cortex 2" Screws	—	AFCTC250LF200	AFCTC750LF200
Woodgrain Cortex 2-3/4" Screws	AFCTL50LF275	AFCTL250LF275	AFCTL750LF275
Woodgrain Collated Cortex 2-3/4" Screws	—	AFCTC250LF275	AFCTC750LF275

	AZEK Model Number		
	50 LN FT	250 LN FT	750 LN FT
<b>PAINTPRO® SCREW, PLUG AND BIT KITS</b>			
Smooth Collated Cortex 2" Screws	—	ATCTC250LF200PP	ATCTC750LF200PP
Smooth Collated Cortex 2-3/4" Screws	—	ATCTC250LF275PP	ATCTC750LF275PP
Woodgrain Collated Cortex 2" Screws	—	AFCTC250LF200PP	AFCTC750LF200PP
Woodgrain Collated Cortex 2-3/4" Screws	—	AFCTC250LF275PP	AFCTC750LF275PP



Paintable Cortex for PaintPro Trim









 **TimberTech**<sup>®</sup>  
Go Against the Grain.<sup>™</sup>

**AZEK**<sup>®</sup>  
Exteriors

The AZEK<sup>®</sup> Company

1330 W. Fulton Street, Suite 350 | Chicago, IL 60607

LIT-PRODUCTGUIDE REV 02 /21