



LARSON® STORM DOORS

REEB® IN-STOCK STORM DOOR CATALOG



Introduction

Adding a Larson® storm door improves energy efficiency of the entryway, reduces maintenance needs, and helps the entry door perform better.

Premium extruded aluminum and durable wood-core components provide superior protection against the elements while adding an abundant array of design options. Retractable, interchangeable and standard screen options offer even more opportunities to achieve the look you desire while helping to keep your home warmer in the winter and cooler in the summertime. All of Larson's extruded aluminum doors include a Limited Lifetime Warranty and the peace of mind that comes with ordering from a top-tier manufacturer.

We know these doors provide great performance and exceptional value, and Reeb® is commitment to stocking over 500 combinations of designs, colors, hardware, finishes and glass options. This selection coupled with a fast lead time makes ordering from Reeb an easy choice when selecting a Larson Storm Door for your next project.



Measuring

Don't get intimidated when it comes to preparing for your new storm door.

Use the image below as a guide to measuring for a storm door. For the width, take one measurement across the top of the door (A), one across the middle (B) and one across the bottom (C). Record the narrowest dimensions. Then, measure the opening height (vertically) as shown (D). Record the dimension.

STANDARD DOOR SIZES	MINIMUM-MAXIMUM DOORWAY WIDTH	MINIMUM-MAXIMUM DOORWAY HEIGHT
30" x 81"	29-7/8" to 30-3/8"	80" to 81"
32" x 81"	31-7/8" to 32-3/8"	80" to 81"
34" x 81"	33-7/8" to 34-3/8"	80" to 81"
36" x 81"	35-7/8" to 36-3/8"	80" to 81"

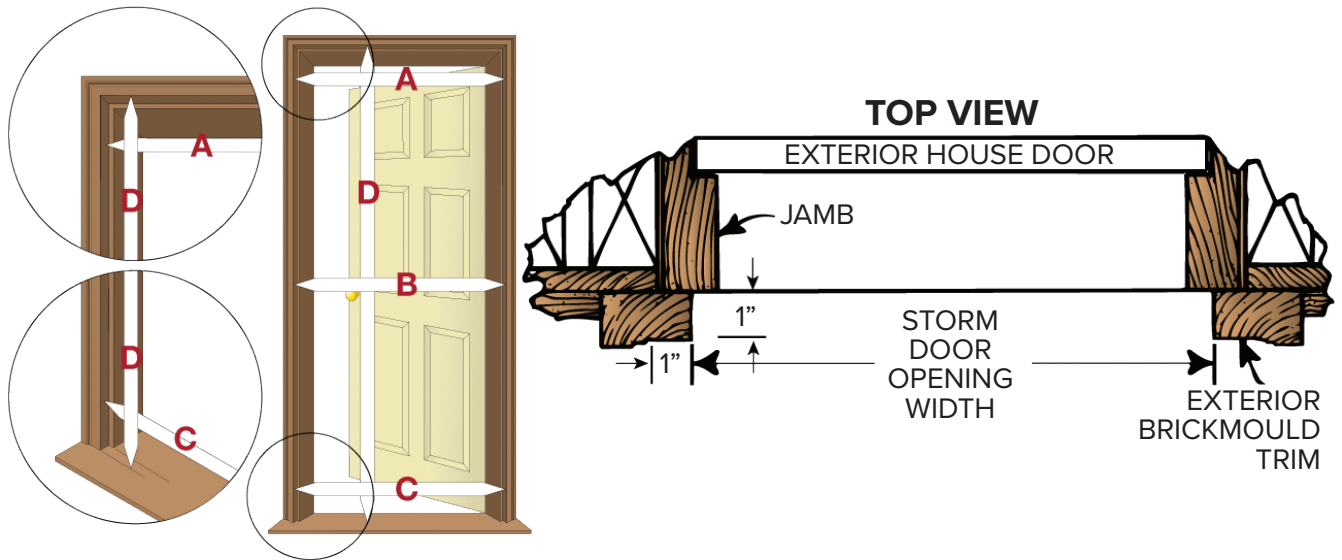

Watch a video on how to measure at

<https://learn.reeb.com/knowledge-base/how-to-measure-for-a-larson-storm-door/>

Table of Contents

Introduction & Measuring	2-3	Secure Elegance®	14-15
Screen Options	4-5	Classic-View®	16-17
Buyer's Guide	6-9	Lifestyle	18
Classic Elegance®	10-13	Life-Core®	19
EasyVent® Retractable Screen	10-11	Vinyl-Clad	20
Elegant Selection™ Interchangeable Screen	12-13	EasyHang® Installation	21

Screen Options

Open Your Home to a Whole New View

Whether you want to let in light, a breeze, or both, Larson® storm doors offer a modern view with convenient features and unparalleled protection.

Retractable Screen



The retractable Screen Away® design converts the storm door to a screen door instantly and discreetly rolls up and hides when not in use.

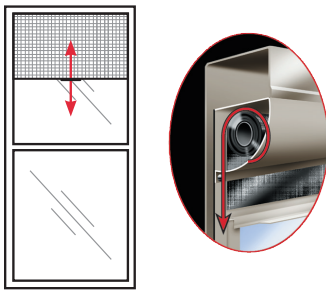

- Built-in screen glides up and down for quick and easy ventilation
- Hides screen discreetly into cassette at top of door
- Provides ventilation and protection from outside elements

Available with:

Classic Elegance®, Lifestyle

Look for this icon:



Interchangeable Screen



The screen and glass are interchangeable, allowing for seasonal ventilation while showcasing the entryway year round.

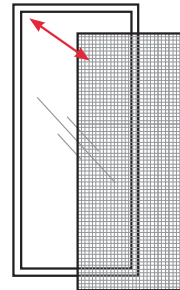

- Provides uninterrupted views from your entrance
- Most include separate glass and screen panels that are used interchangeably
- Protects your entry door

Available with:

Classic Elegance®, Classic-View®

Look for this icon:

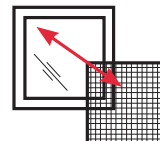

Standard Screen



Reversa Screen

The Reversa Screen has an integrated half screen providing ventilation at the top or the bottom.

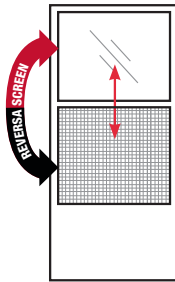

- Integrated screen so no extra storage is needed
- Reversa Screen - Half-fixed screen: Adjustable glass for top or bottom ventilation

Available with:

Classic-View®, Life-Core®

Look for this icon:



Single-Vent

The traditional single-vent half screen allows for the bottom part of the glass to ventilate.

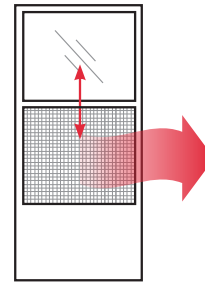

- Integrated screen so no extra storage is needed
- Single Vent - Half-fixed screen: For bottom ventilation

Available with:

Vinyl-Clad

Look for this icon:



Buyer's Guide

No matter the style or design, Larson® storm doors add comfort and security to any home.

When choosing a Larson storm door for your next home or building project, you have a wide selection of materials, technology, color, screen and hardware options to consider. Our comprehensive Buyer's Guide provides an overview of our Larson product offering and lists the unique benefits of each selection. When you're ready to learn more, in-depth product information can be found on corresponding product pages.

Views

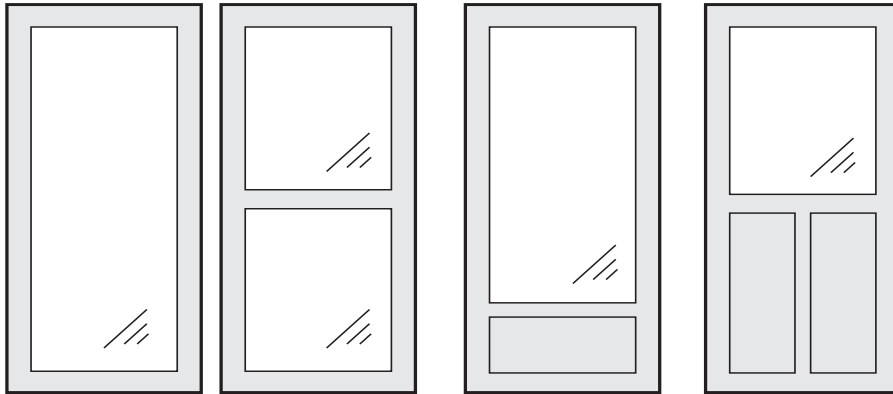

Full-View

Mid-View

High-View

Glass Information

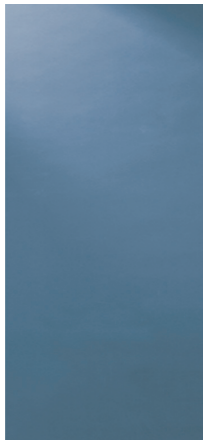

Clear Tempered Glass

Available with all storm doors except Secure-Elegance®.



Double Bevel

Decorative double-bevel full view glass available with Classic Elegance® EasyVent® Selection and Classic Elegance® Elegant Selection™.

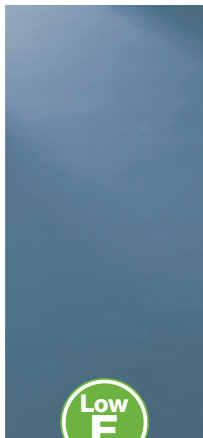

Low-E

High-performance glass offers better year-round insulation and reduces the harmful fading effect of the sun to protect your entry door and floor. Available with Classic Elegance® Series.

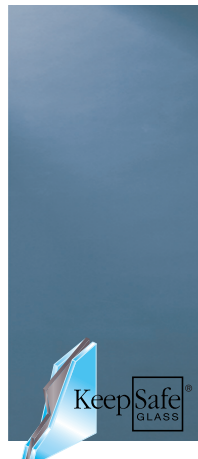

KeepSafe®

KeepSafe® Glass has a laminated security shield between two pieces of factory strengthened glass. When impacted, the broken glass clings to the laminated interlayer and remains intact. The glass is permanently affixed to the frame of the door so it stands up to repeated blows by blunt objects. Available with Secure-Elegance® only.

Classic Elegance®



Retractable Screen

The Classic Elegance® Retractable Screen collection represents the premium offering. They offer the convenience of Screen Away® technology and the widest variety of style, glass, color, hardware and finish options. Each product in this line utilizes a keyed deadbolt lockset for enhanced security and is paired with a **Limited Lifetime Warranty**. For more information, see page **10-11**.

Available Colors:



Interchangeable Screen

The Classic Elegance® Interchangeable Screen collection is an excellent option for those seeking premium quality with seasonal ventilation control. These single-lite doors have no crossbar and feature multiple color and lockset hardware finish options. They include a keyed deadbolt lockset for enhanced security, and are paired with a **Limited Lifetime Warranty**. For more information, see page **12-13**.

Available Colors:



Secure Elegance®



Security Door

The Secure Elegance® collection features a combination of KeepSafe® glass and a powerful 3 point locking system to make this door the most secure storm door available. In addition to the **Limited Lifetime Warranty**, Larson also provides a **\$1000 Break-In Protection Warranty** for added peace of mind. For more information, see page **14-15**.

Available Colors:



Buyer's Guide

Classic-View®



Interchangeable Screen

The Classic-View® Full-View collection is an excellent option for anyone seeking a moderately priced Full-View storm door. This collection sports a slightly thinner construction, and will require extra storage for glass and screens when not in use. All Classic-View® doors include a **Limited Lifetime Warranty**. For more information, see page **16**.

Available Colors:

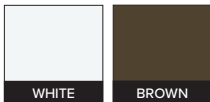

Standard Screen

The Classic-View® Standard Screen is a great choice for those seeking a door with a reinforced kick-panel and a reversible screen which allows for top or bottom ventilation. These doors are available in your choice white or brown with color-matching hardware. All Classic-View® doors include a **Limited Lifetime Warranty**. For more information, see page **17**.

Available Colors:

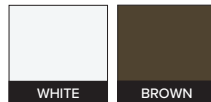

Lifestyle



Retractable Screen

The Lifestyle door is an economy wood core door that includes Screen Away® technology and decorative hardware options. These doors are available in white only and feature a mortise lock with inside locking hardware in two color choices and a **10 year warranty**. For more information, see page **18**.

Available Colors:





The Life-Core® collection is an economy wood core door with unique features that make it more durable in high traffic situations. This is the perfect choice for Landlords and Property Managers who need a door that will stand up well to excessive wear and tear. All Life-Core® doors include a **10 year warranty**. For more information, see page **19**.

Available Colors:



Our Vinyl-Clad offering is an economy wood core door that features standard ventilation and standard hardware. It is available in white only and includes a **5 year warranty**. For more information, see page **20**.

Available Colors:



Hardware Finishes

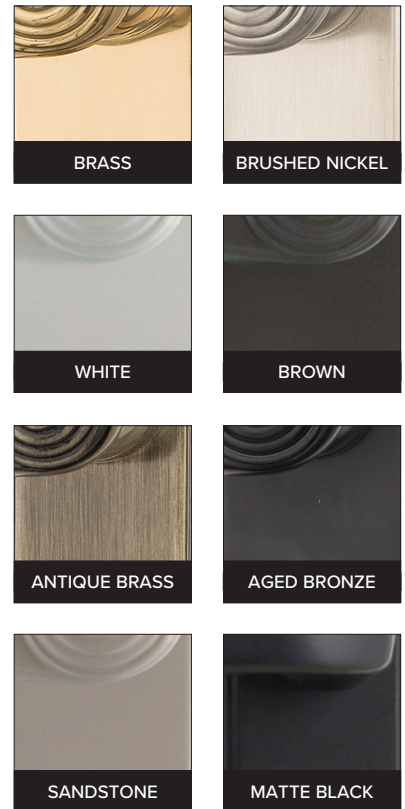

Installation

All Larson® Storm Doors are equipped with EasyHang®. Here are just some of the benefits you can expect when choosing a Larson storm door. Check out page **21** for more information.



What makes the EasyHang® System so easy?

- An exact fit with mounting rail extenders
- Pre-drilled hinge locator holes
- Easy mounting with no cutting or sawing needed

Classic Elegance®

EasyVent® Retractable Screen



The Classic Elegance® EasyVent® Retractable Screen collection uses patented Screen Away® technology which allows the screen to retract into a hidden cassette at the top of the door when not in use for quick and easy ventilation control.

- 1-7/8" thick low-maintenance aluminum frame
- Overlapping frame with double weatherstrip seals out weather and conceals hinges and gaps
- Two closer system color matched to door: bottom closer features Hold Open button that holds storm door open with tap of toe; top closer adds dependable opening and closing
- Bottom expander adjusts to uneven sills
- Self-drilling installation screws
- Designer screw covers conceal exterior mounting screws
- Reversa-Hinge™ for right or left mounts
- EasyVent® balanced window system for easy one-hand operation

1 Choose Your Door



146-FV FULL-VIEW CLEAR	146-FVE FULL-VIEW LOW-E	146-BV FULL-VIEW BEVEL	146-MV MID-VIEW	146-HV HIGH-VIEW		
AVAILABLE SIZES						
30" x 81" - White Only 32" x 81" 36" x 81"	32" x 81" 36" x 81"	36" x 81"	32" x 81" 36" x 81"	32" x 81" 36" x 81"		
AVAILABLE COLORS						
White, Almond, Sandstone, Brown, Green, Cranberry, Black	White, Almond, Sandstone, Brown, Green, Cranberry, Black	White, Almond, Sandstone, Brown, Green, Cranberry, Black	White, Almond, Sandstone, Brown, Green, Cranberry	White, Almond		
WHITE	ALMOND	SANDSTONE	BROWN	GREEN	CRANBERRY	BLACK

Due to the printing process, actual colors may vary from pictures shown

2 Choose Your Handle

QuickFit™
HANDLESET

- Matching interior and exterior handles with Built-in deadbolt security lock
- Easier installation with slide-on template
- Designed exclusively for doors with Larson® QuickFit™ locksets, patented design



NOTE: QuickFit™ handle sets fit only 146 & 149 models listed and cannot be modified for use with older models.

Classic Elegance®

Elegant Selection™ Interchangeable Screen



The Classic Elegance® Elegant Selection™ Interchangeable Screen collection has full-view glass with an interchangeable screen included for seasonal ventilation control.

- 1-5/8" thick low-maintenance aluminum frame
- Overlapping edge with double weatherstrip extends over the door seam to seal out weather and conceal hinges and gaps
- Full screen is included for seasonal ventilation
- Bottom expander adjust to uneven sills
- Self-drilling installation screws
- Designer screw covers conceal exterior mounting screws
- Reversa-Hinge™ for right or left mounts
- Two closer system: bottom closer features Hold Open button that holds storm door open with tap of toe; top closer adds dependable opening and closing

1 Choose Your Door

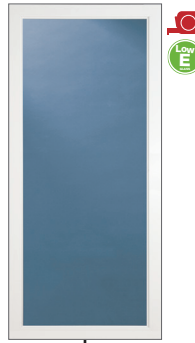
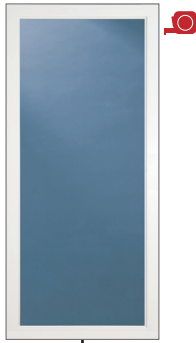

149-FV FULL-VIEW CLEAR	149-FVE FULL-VIEW LOW-E	149-BV FULL-VIEW ARCHED DOUBLE BEVEL
AVAILABLE SIZES		
32" x 81" 36" x 81"	32" x 81" 36" x 81"	36" x 81"
AVAILABLE COLORS		
White, Almond, Sandstone, Brown, Green, Cranberry, Black	White, Almond, Sandstone, Brown, Green, Cranberry, Black	White, Almond, Sandstone, Brown, Green, Cranberry, Black

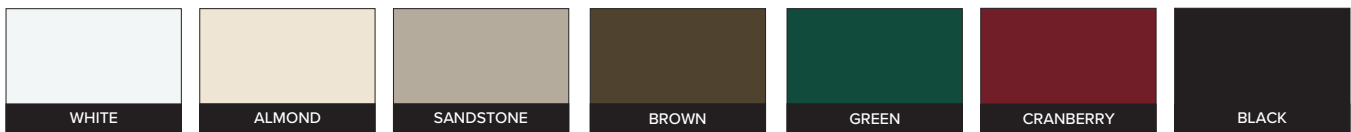

Due to the printing process, actual colors may vary from pictures shown

2 Choose Your Handle

QuickFit™
HANDLESET

- Matching interior and exterior handles with Built-in deadbolt security lock
- Easier installation with slide-on template
- Designed exclusively for doors with Larson® QuickFit™ locksets, patented design



NOTE: QuickFit™ handle sets fit only 146 & 149 models listed and cannot be modified for use with older models.

Secure Elegance®

Security Door



The Secure Elegance® Security Door collection has a \$1000 break-in protection guarantee for KeepSafe® Glass. The glass is permanently affixed to the frame for added security - no screen, no ventilation.

Storm Door Features

- 1-5/8" thick aluminum frame is low-maintenance
- Overlapping edge extends over door seam to seal out weather and conceal hinges and gaps
- Matching levers inside and out with multi-point locking
- Designer screw covers conceal exterior mounting screws
- Two adjustable-speed closers in matching colors
- Bottom expander adjusts to uneven sills
- Reversa-Hinge™ for right or left mounts
- Interchangeable screen not available

Security Features

- Factory strengthened KeepSafe® Glass with security shield inner layer and break-in protection
- Secure Multi-point Locking System secures the door in 3 places adding extra protection from forced entry
- Blocks 99% of UV rays to prevent fading
- Twice as thick glass for added insulation and noise reduction

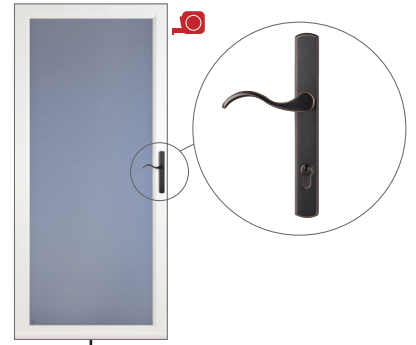
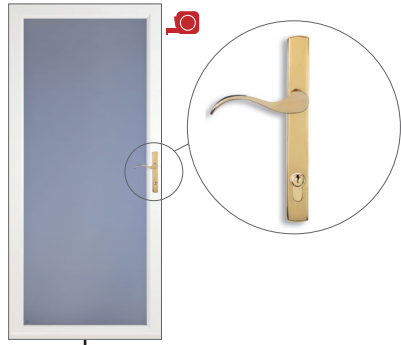

349-20 FULL-VIEW BRASS	349-17 FULL-VIEW BRUSHED NICKEL	349-15 FULL-VIEW AGED BRONZE
AVAILABLE SIZE		
36" x 81"	36" x 81"	36" x 81"
AVAILABLE COLOR		
White	White	White

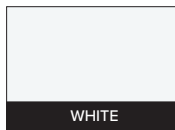

Due to the printing process, actual colors may vary from pictures shown



Secure Elegance® 349-15 in White



Multi-point Locking System

Classic-View®

Interchangeable Screen



The Classic-View® Interchangeable Screen collection has a full-view glass door, with an interchangeable screen included for seasonal ventilation control.

- 1-1/4" thick aluminum frame is low-maintenance
- Heavy-duty weatherstripping
- One color-matched adjustable-speed closer
- Matching levers inside and out with built-in deadbolt security lock
- Bottom expander adjusts to uneven sills
- Reversa-Hinge™ for right or left mounts

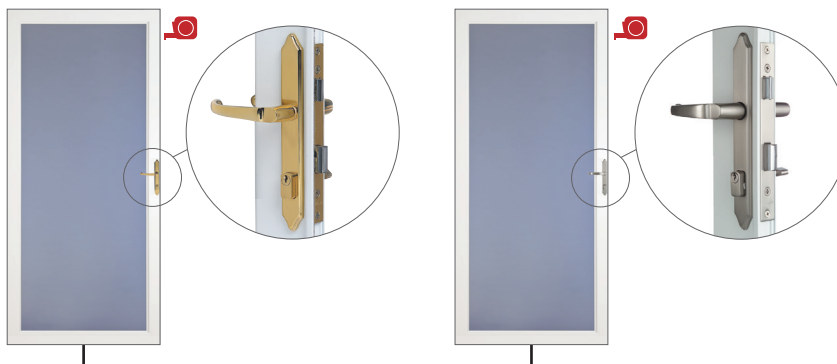

350-04 FULL-VIEW BRASS	350-17 FULL-VIEW BRUSHED NICKEL
AVAILABLE SIZES	
32" x 81" 36" x 81"	32" x 81" 36" x 81"
AVAILABLE COLORS	
White, Brown	White, Brown

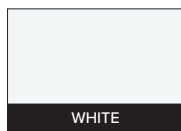

Due to the printing process, actual colors may vary from pictures shown



Available in Custom Sizes.
Please call your Customer Service
Rep for more information.

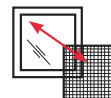

Classic-View®

Standard Screen



The Classic-View® Standard Screen collection has Reversa Screen, which features a reversible half screen allowing for ventilation on top or bottom.

- 1-1/4" thick aluminum frame is low-maintenance
- Rigid steel kick-panel stands up to abuse
- Reversa Screen for top or bottom ventilation
- Durable handle and interior lock
- Pull-up style handle, color matched to door
- Bottom expander adjusts to uneven sills
- One color-matched closer

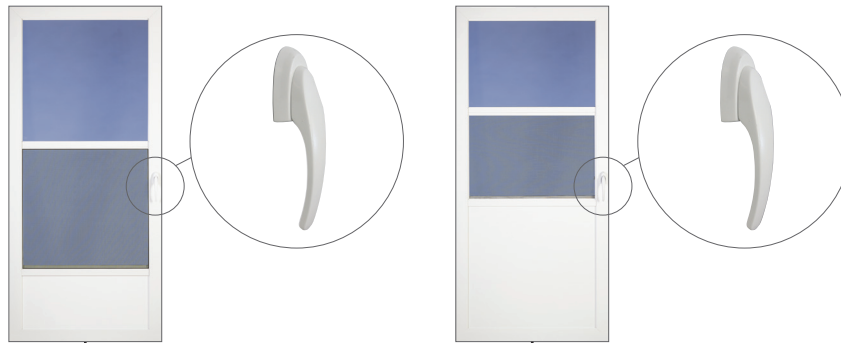

660-16 MID-VIEW PULL-UP	660-18 HIGH-VIEW PULL-UP
AVAILABLE SIZES	
32" x 81" 36" x 81"	32" x 81" 36" x 81"
AVAILABLE COLORS	
White, Brown	White, Brown



Due to the printing process, actual colors may vary from pictures shown



Lifestyle

Interchangeable Screen



The Lifestyle Retractable Screen collection has patented Screen Away® technology that allows for the screen to retract into a hidden cassette at the top of the door when not in use for quick and easy ventilation control.

- DuraTech® surface over solid wood core for age and weather resistance
- Magnetic weatherstrip seals like a refrigerator
- Screen Away® retractable screen disappears in top cassette for a clear view
- Matching interior and exterior Secure Lock® handles with built-in inside lock
- Bottom expander adjusts to uneven sills
- Two adjustable speed closers in matching colors
- Reversa-Hinge™ for right or left mounts



830-80 MID-VIEW BRASS	830-82 MID-VIEW BRUSHED NICKEL
AVAILABLE SIZES	
32" x 81" 36" x 81"	32" x 81" 36" x 81"
AVAILABLE COLOR	
White	White

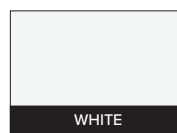

Due to the printing process, actual colors may vary from pictures shown

Life-Core®

Standard Screen



Life-Core® 370-50 in White

The Life-Core® Standard Screen collection has Reversa Screen, which features a reversible half screen allowing for ventilation on top or bottom, with a WearTuff™ screen. The WearTuff™ screen is 3 times stronger than our standard screen for added durability.

- DuraTech® surface over solid wood core for age and weather resistance
- Tear-resistant WearTuff™ Screen is reversible for top or bottom ventilation
- Reversa Screen for top or bottom ventilation
- Strong-hold handle with keyed lock for added security
- High traffic 5 hinge system
- FlexGuard™ closer protects door when over-extended and allows door to open past 90 degrees
- Bottom expander adjusts to uneven sills
- Reversa-Hinge™ for right or left mounts

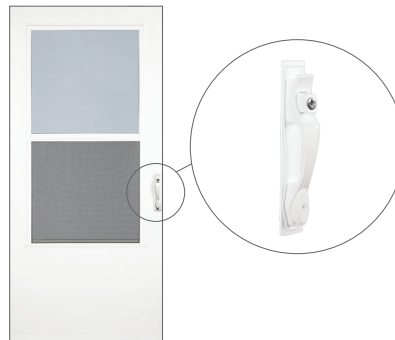

370-50 MID-VIEW PUSH-BUTTON
AVAILABLE SIZES
30" x 81" 32" x 81" 36" x 81"
AVAILABLE COLORS
White, Brown

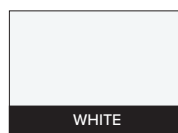

Due to the printing process, actual colors may vary from pictures shown



Vinyl-Clad

Standard Screen



Vinyl-Clad 298-SS in White

The Vinyl-Clad Standard Screen collection are venting storm doors that offer built-in screens so it's easy to let in the breeze. The Single Vent storm doors have a half-screen and provide a single sash for bottom ventilation.

- Vinyl surface over solid wood core
- Durable weatherstrip
- Single-Vent glass and half screen for bottom ventilation
- One adjustable-speed closer
- Durable push-button handle
- Bottom expander adjusts to uneven sills
- Reversa-Hinge™ for right or left mounts



298-SS
AVAILABLE SIZES
30" x 81" 32" x 81" 36" x 81"
AVAILABLE COLOR
White

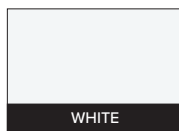

Due to the printing process, actual colors may vary from pictures shown



EasyHang® Installation

Larson® patented installation method is named EasyHang® for a reason.

Here are just some of the benefits you can expect when choosing a Larson storm door.



What makes the EasyHang® System so easy?

Larson Doors Offers:

- An exact fit with mounting rail extenders
- Pre-drilled hinge locator holes
- Easy mounting with no cutting or sawing needed

Easy Jamb Hole Locator System Provides:

- Exact alignment of the hinge rail
- Correct placement to the home

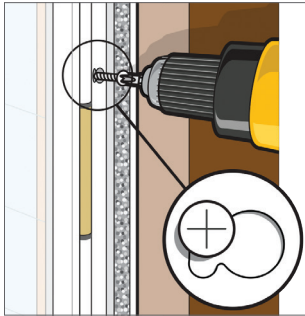

1 Insert hanging screw

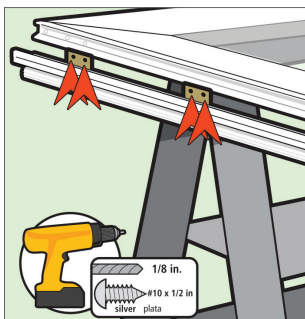

2 Install hinge to door

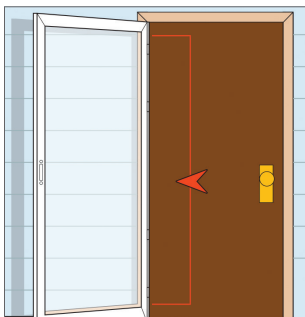

3 Hang door on home

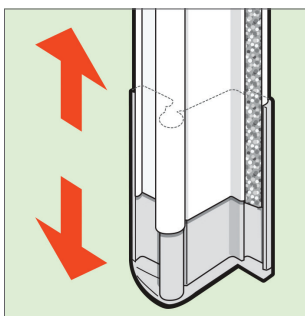

4 Adjust height

Install hardware, expander and enjoy!





Classic Elegance® 146-FV in Almond



Trade-Matched Colors

Larson® Storm Door colors are Trade-Matched to Reeb® Finish Paint colors are Reeb Finish Aluminum Clad colors.

What does Trade-Matched mean? Each paint color is applied to a different substrate and the end results are colors that are similar in appearance but not exact matches. Please view the color comparison chart to see which colors are trade-matched to each other.

View Color Comparison Chart online at reebfinish.com/trade-matched

View Reeb Finish Catalog online at reeb.com/catalogs

Storm and Screen Doors

25 ARTICLES

RLC Home > Knowledge Base > Exterior Products > Storm and Screen Doors



Larson Storm Doors

Exterior Products > Storm and Screen Doors

Larson Storm Doors add an abundant array of choices including full-view, retractable-screen and standard storm doors. Larson doors are available...



Larson Storm Doors Buyer's Guide

Exterior Products > Storm and Screen Doors

No matter the style or design, Larson® storm doors add comfort and security to any home. When choosing a Larson...



Classic Elegance Interchangeable Screen

Exterior Products > Storm and Screen Doors

The Classic Elegance® Elegant Selection™ Interchangeable Screen collection has full-view glass with an interchangeable screen included for seasonal ventilation control...



Vinyl-Clad Standard Screen

POPULAR ARTICLES IN THIS CATEGORY

- Larson Storm Doors
- Combination Door Company
- Classic Elegance Interchangeable Screen
- Vinyl-Clad Standard Screen
- CDC Ultra-Vu
- Larson Glass Options

KNOWLEDGE BASE MAIN CATEGORIES

- Exterior Products
- Interior Products
- Commercial Products
- General Millwork
- Systems



Visit the Reeb® Learning Center for education on choosing the proper door unit, new products, and what product options are available.

Visit the Reeb Learning Center at learn.reeb.com



Online Larson Storm Doors Catalog

For an interactive format of this catalog, please visit reeb.com/catalogs



Warranty Information

View product warranties at reeb.com/catalogs

□ **Bethlehem, PA**

1000 Maloney Cir.
Bethlehem, PA 18015
(800) 862-8622 voice
(800) 772-7332 fax

□ **Barclay, MD**

1315 Goldsboro Rd.
Barclay, MD 21607
(800) 825-8331 voice
(800) 331-9387 fax

□ **Mocksville, NC**

346 Bethel Church Rd.
Mocksville, NC 27028
(800) 642-0886 voice
(800) 618-0620 fax

□ **Providence, RI**

19 Business Park Dr.
Smithfield, RI 02917
(800) 343-5703 voice
(800) 388-5979 fax

□ **Syracuse, NY**

7475 Henry Clay Blvd.
Liverpool, NY 13088
(800) 422-5224 voice
(800) 531-7332 fax



PART# REEBLAR21

VERSION 1.0.0