



EMPIRE

Moulding & Millwork

Northeast Distribution
Center



MOULDINGS | STAIR PARTS | BOARDS | EXTERIOR MILLWORK

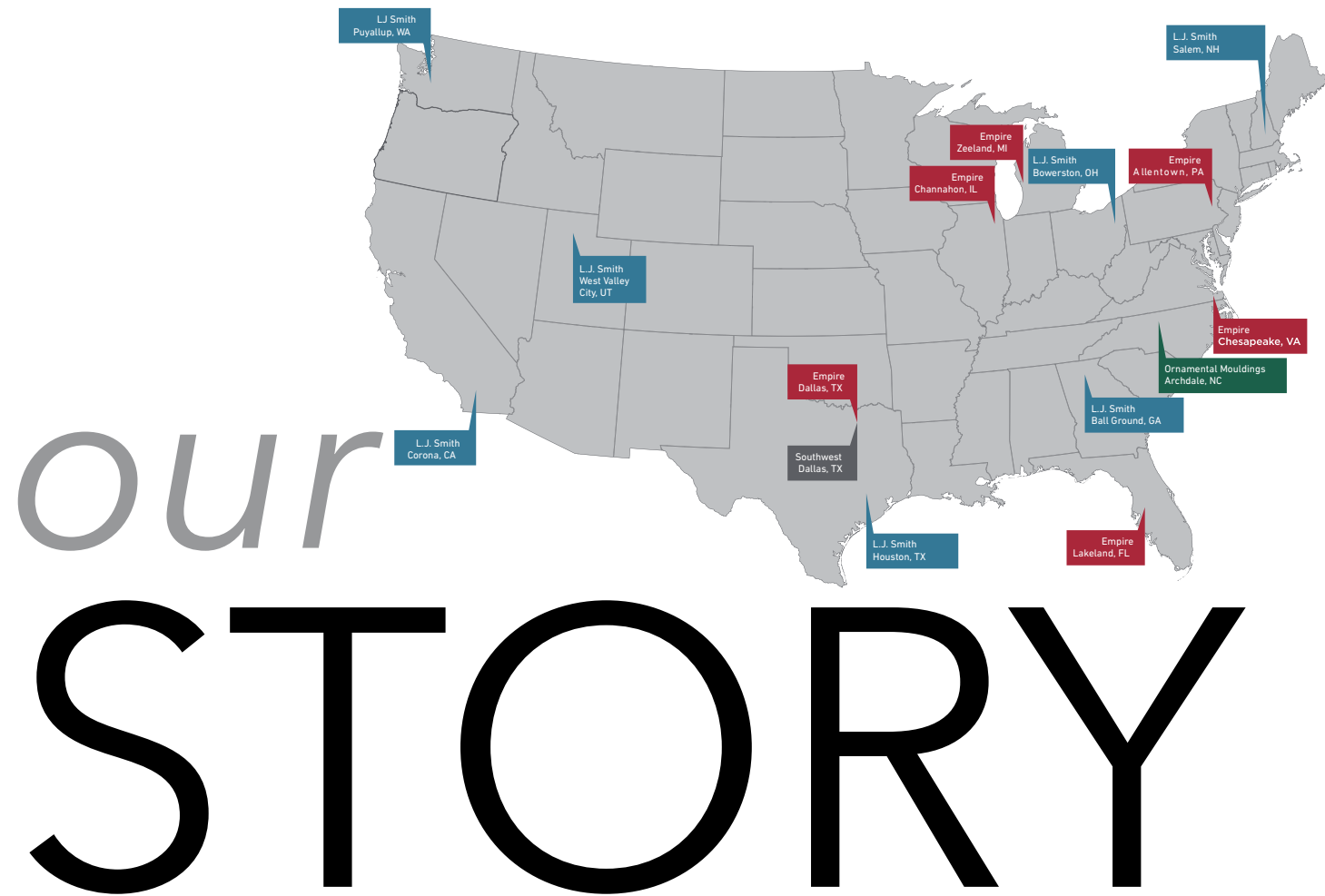

our STORY



DEEP ROOTS. HIGH STANDARDS. BRIGHT FUTURE.

Founded in 1946 Empire has grown into one of the largest millwork distribution and manufacturing companies in the United States.

With a geographic footprint that touches the majority of the eastern half of the United States, Empire is positioned for continued expansion.

our FAMILY



EMPIRE IS NOW A PART OF THE NOVO FAMILY.

Novo Building Products is the industry leading manufacturer and distributor of mouldings, stair parts, doors, and specialty building products. We are proud to serve building material dealers (lumberyards), door shops, retail home centers, and millwork manufacturing partners throughout the United States and parts of Canada and Mexico.

Learn more at [novobp.com](https://www.novobp.com).



REFRESH. REVIVE. RENEW.

TABLE OF CONTENTS

- INSPIRATION.....8-19
- BUILD-UPS.....20-21
- OMI DECORATIVE ACCESSORIES.....22-26
- FLEXIBLE MOULDING.....27
- BOARDS.....28
- DOOR JAMBS.....29
- CASING.....30-32
- ARCHITRAVES.....33
- ROSETTES & PLINTH BLOCKS.....34
- CORBELS & CORNER BLOCKS.....35
- BASE CAPS.....36
- BASE.....36-39
- CROWN.....40-43
- CROWN BLOCKS.....44
- WINDOW & DOOR MISC.....44
- STOOLS & SILLS.....45
- STOPS.....46
- MULLIONS.....46
- PANEL, CAP, BACK BAND.....47
- CHAIR RAIL.....47
- MISCELLANEOUS.....48
- RAILS.....49
- WALL PANELS.....49
- LJ SMITH STAIR PARTS.....50-67
- TURNCRAFT COLUMNS.....68-69
- PARTS INDEX.....70-71



Achieve a similar look using: **1x6 EC** Wainscoting (V-Groove side)
445 Casing | **623** Base | **126** Shoe

Style is individual, personal, and unique.
Make your room a reflection of you...

DISCOVER

YOUR STYLE HERE

Introducing

The new and improved **Empireco.com**. Explore our comprehensive collections of mouldings, stair parts, boards, and exterior millwork as well as find inspiration for every room in the home.

Classic



Achieve a similar look using: Chair Rail | **041** Crown | **5030** Architrave | **445A** Casing plus **281** Back Band | **738** Base

Classic

Colonial, Ranch, Traditional, Midwestern, Early American, Inviting and Timeless...

Classic Mouldings enhance any home style from Midwestern to Early American, and blend perfectly with the classic style furnishing and timeless building materials of today. Empire has a vast selection of classic style mouldings to match and enhance your style.

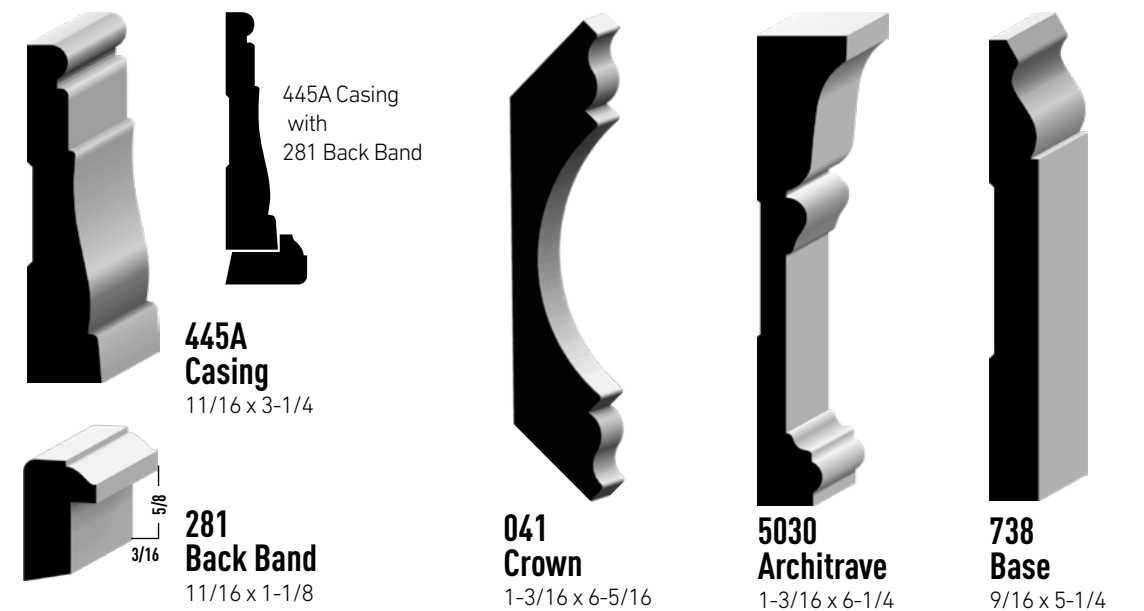

Profiles shown are not to scale.



Bohemian



Achieve a similar look using: **1x3** S4S Board | **1x4** Casing | **1x6** Base | **126** Shoe

Bohemian

Eclectic, Artistic, Avant-Garde; Full of life, culture, color, texture, unique and found objects.

The Bohemian look is as unique as your own personality, combining color, texture, and finishes in a room that is both full of variety and styles that reflect your taste. It is full of life and yet inviting you in to relax. Empire has a wide variety of moulding styles that can be combined to make a room as unique as you. Use any moulding style with a mix of eclectic furnishings and accessories to create a one of a kind flair.



1x6 Board



1x4 Board



1x3 Board



126 Shoe
1/2 x 3/4



713 Base
9/16 x 3-1/4

Options



327 Casing
11/16 x 2-1/4

Profiles shown are not to scale.

Glam



Achieve a similar look using: **L 47** Crown | **300** Chair Rail | **L 956W** Backer | **RB3** Casing | **163** Base Cap | **B312** Base | **126** Shoe

Glam

Ornate, Art Deco, Baroque, Southern Plantation, Colonial Estate...

Decorative Mouldings can transform the bland into a bold statement of line and form. Ornate mouldings can be combined to restore a great Painted Lady or add a subtle flair and richness to add Glam to any room in your home.



L 47
Crown
9/16 x 4-5/8



L 956W
Backer Bead
7/16 x 4-1/4



300
Chair Rail
1-1/16 x 3



RB3
Casing
1 x 3-1/2



B 312
Base
19/32 x 5-1/4



163 Base Cap
11/16 x 1-3/8



126
Shoe
1/2 x 3/4

Rustic



Achieve a similar look using: **1x6 EC** Wainscoting | **EC512** Crown | **1x6** Shiplap | **5010** Architrave | **E412 E2E** Casing | **512E E1E** Base | **126** Shoe

Rustic

Natural and Painted Woods, Handcrafted, Cottage, Frontier Simplicity...

Empire stocks a wide variety of hardwood and primed mouldings, boards, and wall panels from wainscoting, bead-board to shiplap that combine to create a rich rustic space. From ceiling to walls, fill your home with the timeless warmth and comfort of simpler days.



1 x 6

Actual: 11/16-in x 5-3/8-in x 8-ft
SHIPLAP



1 x 4

Actual: 11/16-in x 3-1/2-in x 8-ft
TRIM BOARD

Rustic Shiplap and Trim Options



WOOD

Woodshed
4 WOOD 8 RBWPP
6 WOOD 8 RBWPP



SILO

Silo
4 SILO 8 RBWPP
6 SILO 8 RBWPP



WWHT

Weathered White
4 WWHT 8 RBWPP
6 WWHT 8 RBWPP



Craftsman



Achieve a similar look using: **400** Crown | **5010** Architrave | **B G312** Casing | **B G512** Base | **L 254** Shoe

Craftsman

Handcrafted, Architectural, Craftsman, Modern-Farmhouse, Western Ranch...

Craftsman Mouldings are unique in their adaptability to style from Modern Industrial, Arts and Crafts Architectural and Bungalow to Modern-Farmhouse and Art Deco. They are easily combined with other mouldings complementing your style.



400
Crown
11/16 x 4-1/4



5010
Architrave
1-3/16 x 4-1/4



B G312
Casing
11/16 x 3-1/2



B G512
Base
9/16 x 5-1/2

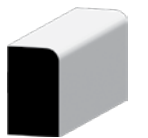

L 254
Shoe
7/16 x 3/4

Profiles shown are not to scale.

Crown

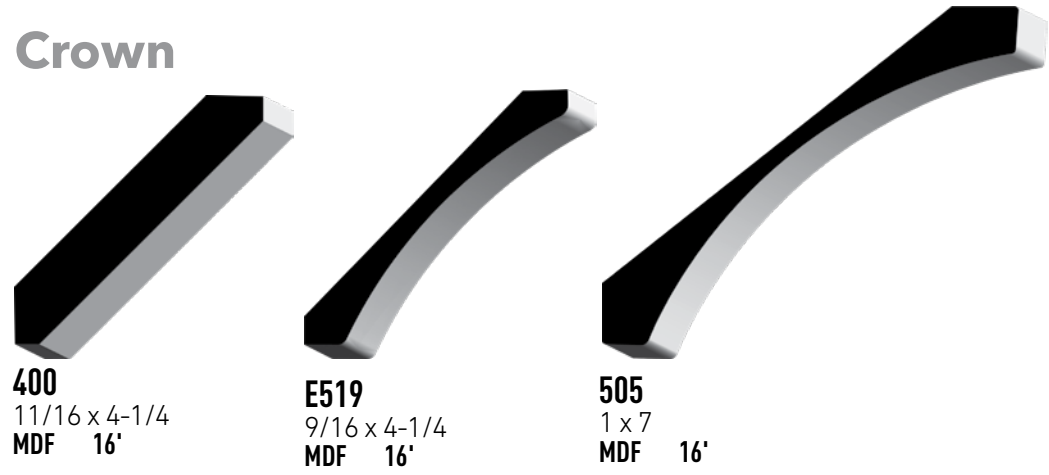

Shoe

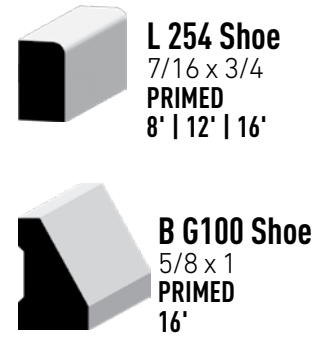

Base Cap | Base

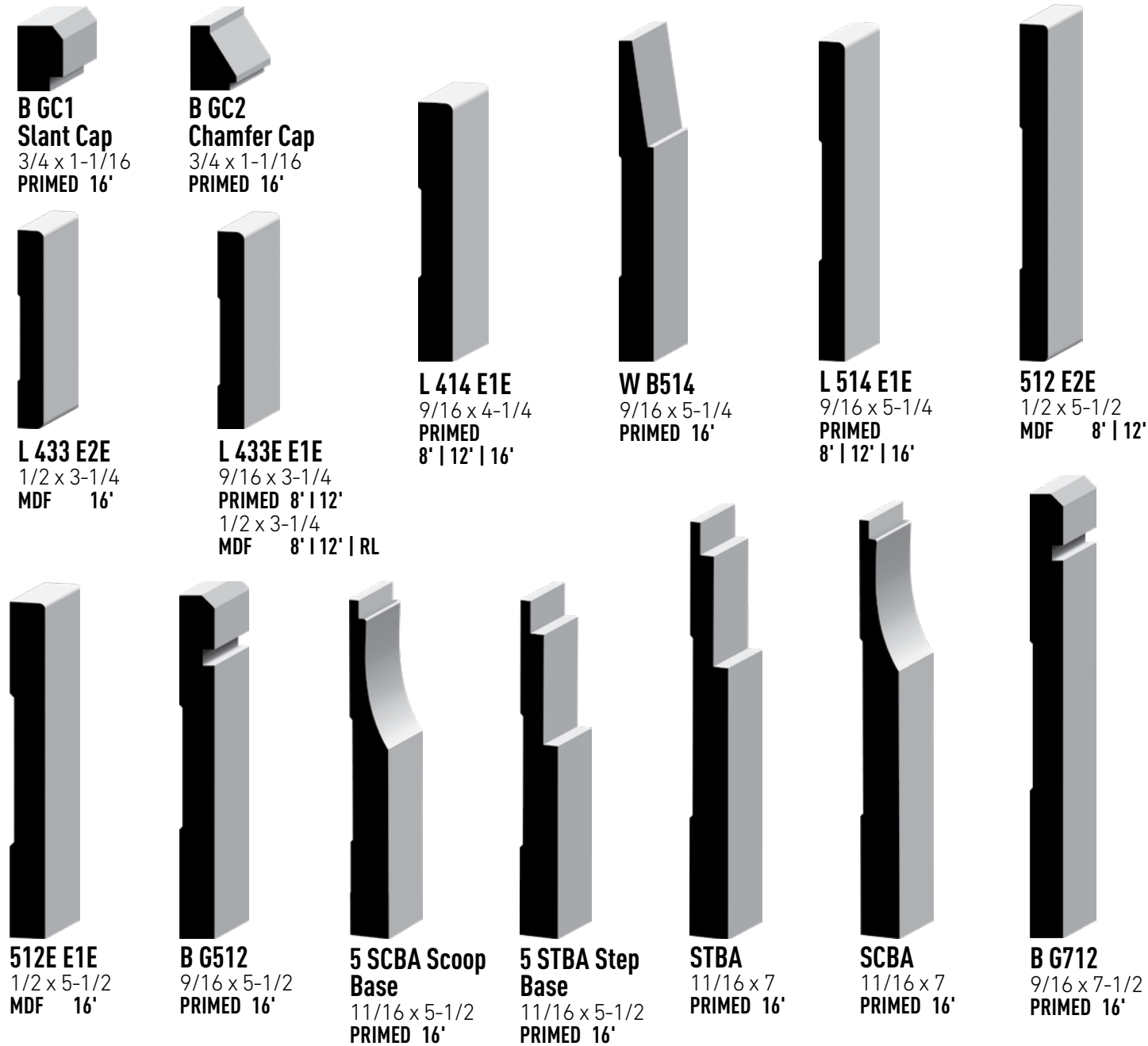

Back Band

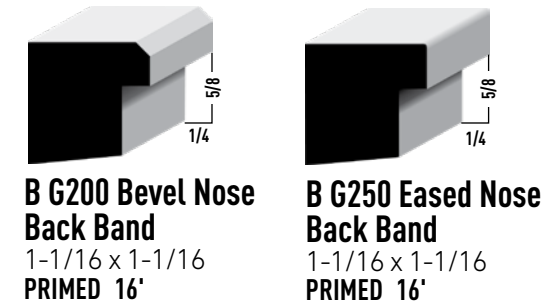

Casing

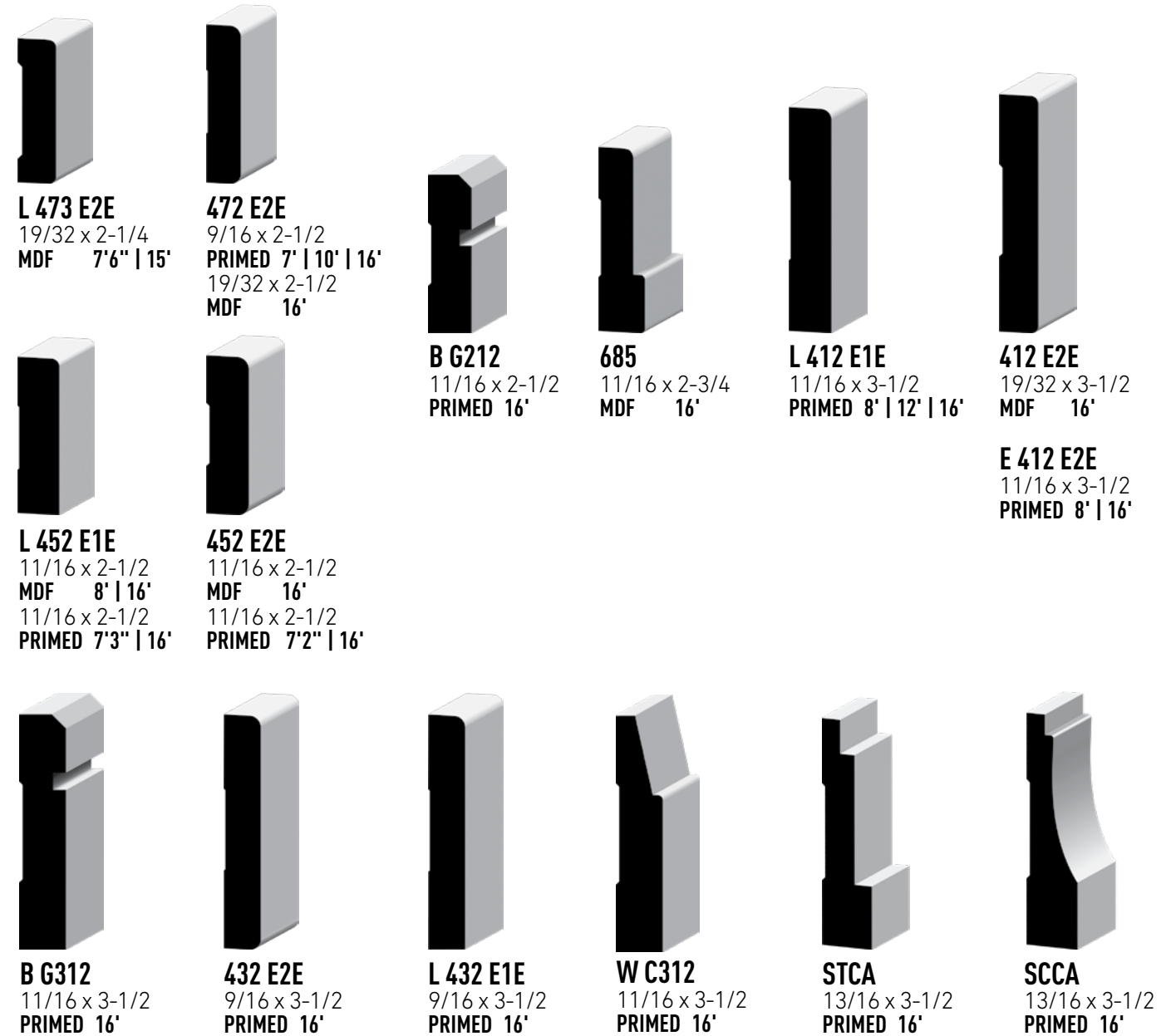

Build-Ups

Combine moulding patterns to create a unique home style.

- Combine crowns, bases, casing, panel moulds, shoe or quarter rounds and more, to create detail, line and pattern.
- Use boards or square stock to build up depth.
- Combine square and eased edges to create richer detail.
- Use moulding with the same style families for a harmonious feel.
- Create completely unique build-ups to fit your own style.



Build-Ups can dramatically change any space adding rich detail for low-cost.

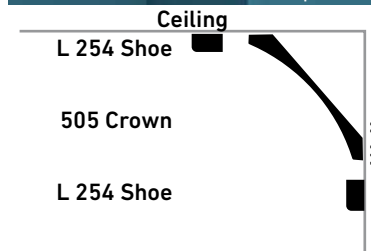
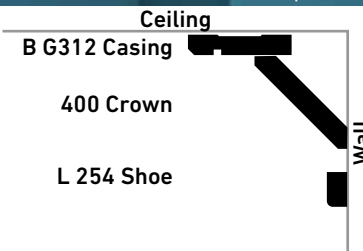

Build-Up combinations are as limitless as your imagination. Create a look that is uniquely you.

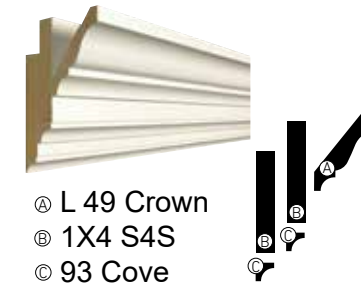

Build-Ups | Chair Rail

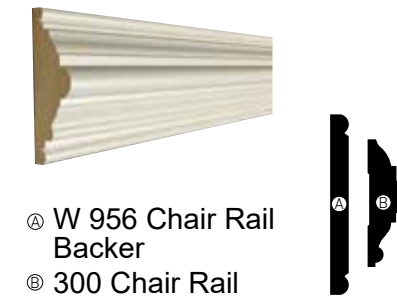

Build-Ups | Casing



Build-Ups | Base

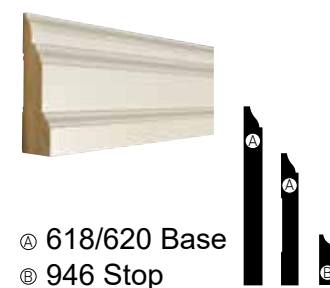

Decorative Accessories



Expressing a style comes easier and has greater impact when your choices—from ceiling to floor—are all unified. For nearly 100 years, Ornamental Mouldings has been providing distinctive, high-quality millwork to make entire living spaces more beautiful. Our decorative accessory styles inspired by tradition and shaped by the latest trends complement one another for unmatched selection, all in one place.

Mantels and Floating Shelves



Whenever people enter a room, their eyes instantly take stock of the space. Reward their gaze with our Mantels and Floating Shelves, which marry function with details that convey a discerning sensibility.

Pattern	Product	H	D	L	Species
3 Ft. Mantel	RUSTIC3WM	5	7	36	Rustic maple
4 Ft. Mantel	RUSTIC4WM	5	7	48	
5 Ft. Mantel	RUSTIC5WM	5	7	60	
6 Ft. Mantel	RUSTIC6WM	5	7	72	

3 Ft. Mantel with insert	RUSTIC3WM-01BK	5	7	36	Rustic maple with aspen insert
4 Ft. Mantel with insert	RUSTIC4WM-01BK	5	7	48	
5 Ft. Mantel with insert	RUSTIC5WM-01BK	5	7	60	
6 Ft. Mantel with insert	RUSTIC6WM-01BK	5	7	72	

4 Ft. Mantel	CLASSIC4WHW	3 3/4	7 3/4	48	WHW
5 Ft. Mantel	CLASSIC5WHW	3 3/4	7 3/4	60	WHW
6 Ft. Mantel	CLASSIC6WHW	3 3/4	7 3/4	72	WHW

5 Ft. Mantel	CLASSIC50AK	3 3/4	7 3/4	60	Oak
6 Ft. Mantel	CLASSIC60AK	3 3/4	7 3/4	72	Oak



Farmhouse | **OML14B, OML24C** | Mantel and Beams

Wood Beams



Practical elements like ceiling beams and wooden stairs are prime places for expressing your style. Our Wood Beams and Decorative Stair Parts give you the tools to achieve drama or convey delicate detailing.

Pattern	Product	H	W	L	Species
Prefinished gray beam	BEAMGRAY-8WHW5x3	3	5	96	Gray WHW
Prefinished gray beam	BEAMGRAY-8WHW5x5	5	5	96	Gray WHW

Rustic maple beam	BEAMRUSTIC-8WM5x3	3	5	96	Rustic maple
Rustic maple beam	BEAMRUSTIC-8WM5x5	5	5	96	Rustic maple

3 inch metal beam-band/bracket	BR-0003MTL	3 9/64	1 1/2	6 7/16	Metal
5 inch metal beam-band/bracket	BR-0005MTL	5 17/64	1 1/2	6 5/16	Metal



Rustic | BR-0001WM, BEAMGRAY-8WHW5x5, 1248C, 1536, 917PB, 1537



Modern Farmhouse | PD001MD742PRIM

Decorative Boards

Create an impact that is more than meets the eye. Use our Decorative Boards to express your creativity with combinations that even at first glance speak volumes about your personal style.



Pattern	Product	W	T	L	Species
Decorative boards	AMAP 1/2X2X96	1 1/2	7/16	96	Ambrosia Maple
	WOAK 1/2x2x96	1 1/2	7/16	96	White Oak
Decorative boards eased edge two sides	1538-8GRAY	1 1/2	7/16	96	Gray Stain
	1538-8BLACK	1 1/2	7/16	96	Black Stain
Decorative boards	AMAP 1/2X4X96	3 1/2	7/16	96	Ambrosia Maple
	WOAK 1/2X4X96	3 1/2	7/16	96	White Oak
Decorative boards eased edge two sides	1536-8GRAY	3 1/2	7/16	96	Gray Stain
	1536-8BLACK	3 1/2	7/16	96	Black Stain
Decorative boards	AMAP 1/2X6X96	5 1/2	7/16	96	Ambrosia Maple
	WOAK 1/2X6X96	5 1/2	7/16	96	White Oak
Decorative boards eased edge two sides	1537-8GRAY	5 1/2	7/16	96	Gray Stain
	1537-8BLACK	5 1/2	7/16	96	Black Stain

Decorative Stair Parts

Pattern	Product	H	W	T	Species
Primed reversible decorative stair riser	PD001MD742PRIM	7 1/2	42	11/32	MDF
	PD001MD748PRIM	7 1/2	48	11/32	MDF



Primed reversible decorative oak stair riser	PD0020AK742PRIM1	7 1/2	42	11/32	Oak/Prime
	PD0020AK748PRIM1	7 1/2	48	11/32	Oak/Prime





Custom Moulding

by ORNAMENTAL MOULDING & MILLWORK



Quality custom or short run moulding orders with quick turn around!

Specs

- 6-16 ft. lengths (random / clear) - Prime available up to 12 ft.
- Profile max = 11-3/4" width
- Minimum run = 3,000 ft. (less than charge can be applied)
- Unique capabilities: rope, dentil, emboss, carving
- Custom tooling charge may apply



Material

- Solid Pine, Poplar, Oak (Red or White), Knotty Alder (up to 10 ft.), Others available upon request

Timing

- Quote turnaround = 2-3 days
- Please contact your Sales Representative

Made in the USA

800.253.9000 | EMPIRECO.COM



Prominent. Beautiful. *Flexible.*

Flexible mouldings available in thousands of profiles

(Special Order — Call for details)



Half Round

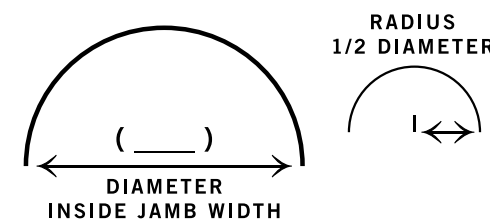

Arcs

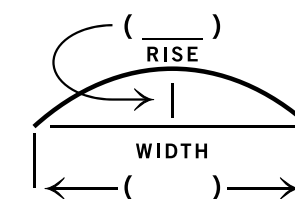

Ellipses

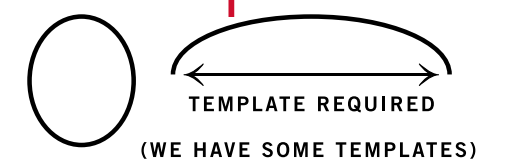

Radius Crown

CONVEX-OSR FOR CROWN & CEILING BACKER

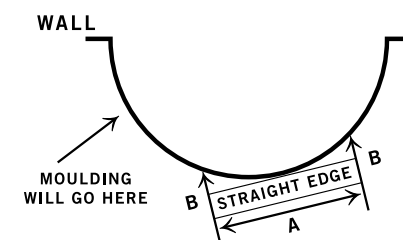

WE NEED "A" LENGTH "B" DISTANCE & "C" LENGTH

CONCAVE-ISR FOR CROWN & CEILING BACKER

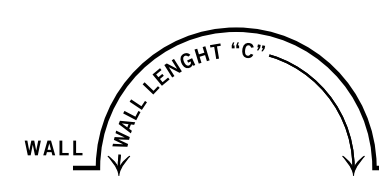
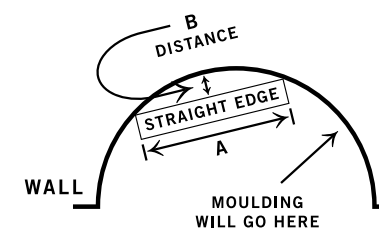

WE NEED "A" LENGTH "B" DISTANCE & "C" LENGTH



Boards



250 Board Feet RL Mini-Packs Available Oak | Poplar

ULTRALITE MDF SHEETS Sold in full units only

344 8 FBDBA	
(18mm) 3/4" thick x 49" wide x 8' long	Around 53 Sheets Per Unit
344 10 FBDBA	
(18mm) 3/4" thick x 49" wide x 10' long	Around 53 Sheets Per Unit
S124 8 FBDBA	
(12mm) 1/2" thick x 49" wide x 8' long	Around 80 Sheets Per Unit
584 8 FBDBA	
5/8" thick x 49" wide x 97" long	Around 64 Sheets Per Unit

Limited quantities.



PINE



OAK

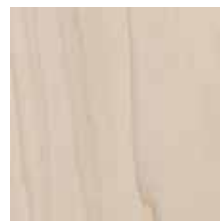

POPLAR

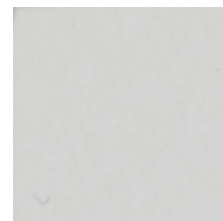

PRIMED

1 X 2	23/32 x 1-1/2	PRIMED	8' 12'
1 X 3	23/32 x 2-1/2	PRIMED	16'
1/2 X 4	1/2 x 3-1/2	PRIMED	16'
1/2 X 6	1/2 x 5-1/2	PRIMED	16'
1 X 4	3/4 x 3-1/2	PINE	8' 10' 12' 14' 16'
	23/32 x 3-1/2	PRIMED	8' 16'
	11/16 x 3-1/2	MDF	8' 16' 17'
	3/4 x 3-1/2	OAK	8' 10' 12' 16'
	3/4 x 3-1/2	POPLAR	8' 10' 12' 16'
1 X 5	23/32 x 4-1/2	PRIMED	16'
1 X 6	3/4 x 5-1/2	PINE	8' 10' 12' 14' 16'
	23/32 x 5-1/2	PRIMED	8' 16'
	11/16 x 5-1/2	MDF	8' 16'
	3/4 x 5-1/2	OAK	8' 10' 12' 14' 16'
	3/4 x 5-1/2	POPLAR	8' 10' 12' 16'
1 X 8	3/4 x 7-1/4	PINE	8' 10' 12' 14' 16'
	23/32 x 7-1/4	PRIMED	16'
	11/16 x 7-1/4	MDF	8' 16'
	3/4 x 7-1/4	OAK	8' 10' 12' 16'
	3/4 x 7-1/4	POPLAR	8' 10' 12' 16'
1 X 10	3/4 x 9-1/4	PINE	8' 10' 12' 14' 16'
	23/32 x 9-1/4	PRIMED	16'
	11/16 x 9-1/4	MDF	16'
	3/4 x 9-1/4	OAK	8' 10' 12' 14' 16'
	3/4 x 9-1/4	POPLAR	8' 10' 12' 16'
1 X 12	3/4 x 11-1/4	PINE	8' 10' 12' 14' 16'
	23/32 x 11-1/4	PRIMED	16'
	11/16 x 11-1/4	MDF	16'
	3/4 x 11-1/4	OAK	8' 10' 12' 14'
	3/4 x 11-1/4	POPLAR	8' 10' 12' 16'
5/4 X 4	1-1/16 x 3-1/2	PRIMED	16'
		POPLAR	RL only available in Mini-Pack
5/4 X 6	1-1/16 x 5-1/2	PRIMED	16'
		POPLAR	RL only available in Mini-Pack
5/4 X 8	1-1/16 x 7-1/4	PRIMED	16'
		POPLAR	RL only available in Mini-Pack
5/4 X 10	1-1/16 x 9-1/4	PRIMED	16'
		POPLAR	RL only available in Mini-Pack
5/4 X 12	1-1/16 x 11-1/4	PRIMED	16'
		POPLAR	RL only available in Mini-Pack

Door Jambs

	JAMB SIZE	DIMENSION	BELOW DADO	PRIMED	PINE VENEER
	L 458 6'8"	11/16 X 4-5/8 JAMB PAIR W/ LUG	81"	X	
	478 6'8"	11/16 X 4-7/8 JAMB PAIR	81"	X	
	L 478 6'8"	11/16 X 4-7/8 JAMB PAIR W/ LUG	81"	X	
	678 6'8"	11/16 X 6-7/8 FLAT JAMB PAIR	81"	X	
	4916 6'8"	11/16 X 4-9/16 JAMB PAIR	81"	X	X
	6916 6'8"	11/16 X 6-9/16 JAMB PAIR	81"	X	X
6'9" FLAT JAMBS	L 6916 6'8"	11/16 X 6-9/16 JAMB PAIR W/ LUG	81"	X	
	L 358 6'9"	11/16 X 3-5/8 FLAT JAMB PAIR W/ LUG	81-1/2"	X	
	L 458 6'9"	11/16 X 4-5/8 JAMB PAIR W/ LUG	81-1/2"	X	
	478 6'9"	11/16 X 4-7/8 FLAT JAMB PAIR	81-1/2"	X	
	L 478 6'9"	11/16 X 4-7/8 JAMB PAIR W/ LUG	81-1/2"	X	
	4916 6'9"	11/16 X 4-9/16 JAMB PAIR	81-1/2"	X	
7'0" FLAT JAMBS	6916 6'9"	11/16 X 6-9/16 JAMB PAIR	81-1/2"	X	
	L 6916 6'9"	11/16 X 6-9/16 JAMB PAIR	81-1/2"	X	X
	378 7'0"	11/16 X 3-7/8 JAMB PAIR	85"	X	
	478 7'0"	11/16 X 4-7/8 FLAT JAMB PAIR	85"	X	
8'0" FLAT JAMBS	4916 7'0"	11/16 X 4-9/16 JAMB PAIR	85"	X	
	378 8'0"	11/16 X 3-7/8 JAMB PAIR	97"	X	
	478 8'0"	11/16 X 4-7/8 FLAT JAMB PAIR	97"	X	
8'1" FLAT JAMBS	678 8'0"	11/16 X 6-7/8 FLAT JAMB PAIR 97BD	97"	X	
	4916 8'0"	11/16 X 4-9/16 JAMB PAIR	97"	X	
	6916 8'0"	11/16 X 6-9/16 JAMB PAIR	97"	X	
	L 458 8'1"	11/16 X 4-5/8 JAMB PAIR W/ LUG	97-1/2"	X	
SPLIT JAMBS	L 478 8'1"	11/16 X 4-7/8 JAMB PAIR W/ LUG	97-1/2"	X	
	L 6916 8'1"	11/16 X 6-9/16 JAMB PAIR W/ LUG	97-1/2"	X	
	514 6'8"	1-1/16 X 2-3/4 SPLIT JAMB PAIR	81"	X	
LINEAL JAMBS	2 4916 6'8"	4-9/16 X 2-3/4 X 2-1/2 SPLIT JAMB PAIR	80-9/16"	X	
	4916 R7 (17')	11/16 X 4-9/16 JAMB LINEAL	NA	X	
	6916 R7 (17')	11/16 X 6-9/16 JAMB LINEAL	NA	X	

Casing

Casing



327
11/16 x 2-1/4
PRIMED 7' | 10' | 14'
PINE 7' | 8' | 10' | 16'



376
19/32 x 2-1/4
MDF 7'1" | 14'
11/16 x 2-1/4
PRIMED 7'1" | 10'
14' | 16'
PINE 7' | 10' | 14'



L 356
1/2 x 2-1/4
OAK 7' | 10'



356
19/32 x 2-1/4
MDF 14'
11/16 x 2-1/4
PRIMED 7'1" | 10'
14' | 16'
PINE 7' | 10'
5/8 x 2-1/4
OAK 7'



366
11/16 x 2-1/4
PRIMED 7' | 10'
14' | 16'
PINE 7' | 10'



366A
19/32 x 2-1/4
MDF 7' | 14'



685
11/16 x 2-3/4
MDF 16'



312
19/32 x 3
MDF 8'



37
11/16 x 3-1/4
PRIMED 16'



445
19/32 x 3-1/4
MDF 7'3" | 16'
11/16 x 3-1/4
PRIMED 7'3" | 8' | 11' | 16'
PINE 8' | 16'



L 473 E2E
19/32 x 2-1/4
MDF 7'6" | 15'



472 E2E
9/16 x 2-1/2
PRIMED 7' | 10' | 16'
19/32 x 2-1/2
MDF 16'



452 E2E
11/16 x 2-1/2
MDF 16'
11/16 x 2-1/2
PRIMED 7'2" | 16'



L 452 E1E
11/16 x 2-1/2
MDF 16'
11/16 x 2-1/2
PRIMED 7' | 7'3" | 10' | 16'



B G212
11/16 x 2-1/2
PRIMED 16'



331
11/16 x 2-1/2
PINE 7' | RL



445A
11/16 x 3-1/4
MDF 16'



L CC14
3/4 x 3-1/4
MDF 16'



PT3
1 x 3-1/4
MDF 8'



682
1 x 3-1/4
MDF 16'

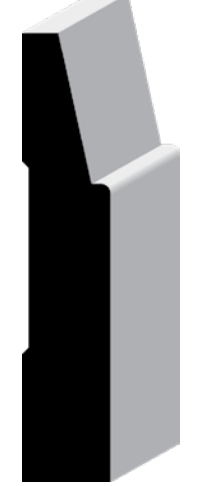

W C312
11/16 x 3-1/2
PRIMED 16'



315
19/32 x 2-1/2
MDF 7'
11/16 x 2-1/2
PRIMED 7' | 10'
PINE 7'



351
11/16 x 2-1/2
PRIMED 7' | 10' | 14'
PINE 7' | 10'



361
19/32 x 2-1/2
MDF 14'
11/16 x 2-1/2
PRIMED 7' | 10' | 14'
PINE 7' | RL



L BRB3
3/4 x 2-1/2
PRIMED 16'



4520
11/16 x 2-3/4
MDF 15'

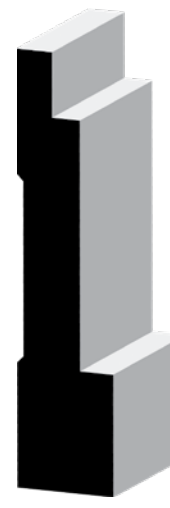

STCA
13/16 x 3-1/2
PRIMED 16'



SCCA
13/16 x 3-1/2
PRIMED 16'



444A
11/16 x 3-1/2
MDF 16'



B G312
11/16 x 3-1/2
PRIMED 16'



535
11/16 x 3-1/2
MDF 16'
5/8 x 3-1/2
PRIMED 16'

Casing



L 412 E1E
11/16 x 3-1/2
PRIMED 8' | 12' | 16'



E 412 E2E
11/16 x 3-1/2
PRIMED 8' | 16'



412 E2E
19/32 x 3-1/2
MDF 16'



432 E2E
9/16 x 3-1/2
PRIMED 16'



L 432 E1E
9/16 x 3-1/2
PRIMED 16'



L 361
11/16 x 3-1/2
PRIMED 16'



444
11/16 x 3-1/2
PRIMED 7'3" | 8'
12' | 16'
PINE 8'



L 445 (99)
11/16 x 3-1/2
PRIMED 16'



W 331
11/16 x 3-1/2
PINE RL

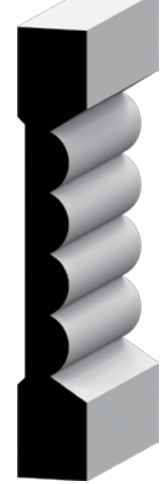

1006
9/16 x 3-5/8
PRIMED 7'



M DC97
3/4 x 3-1/2
PRIMED 16'



RB3
1 x 3-1/2
MDF 16'



DC97
1 x 3-1/2
MDF 8' | 16'
1-1/16 x 3-1/2
PRIMED 7'4" | 16'



S RB3
1-1/16 x 3-1/2
PRIMED 16'



LK4 CASING
1-1/8 x 4
MDF 16'



B100
11/16 x 4-1/4
PINE 8'

Architraves



Pictured: SL16 Shiplap | 5030 Architrave | E412 E2E Casing



5010 Architrave
1-3/16 x 4-1/4
MDF 16'

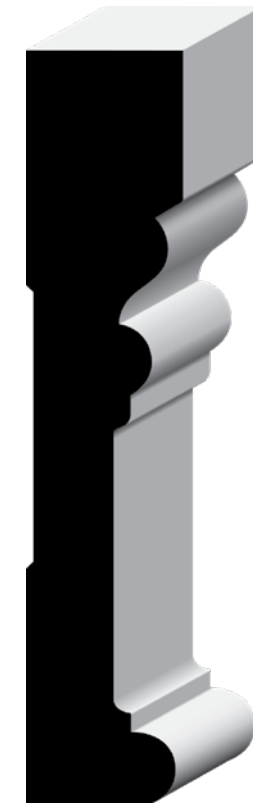

5021 Architrave
1-1/8 x 5-5/16
MDF 16'



5030 Architrave
1-3/16 x 6-1/4
MDF 16'

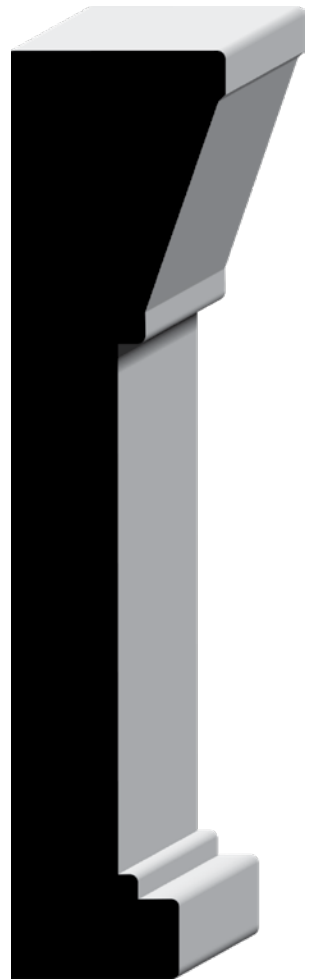

SA612 Architrave
1-1/2 x 6-1/2
MDF 16'

Rosettes | Plinth Blocks

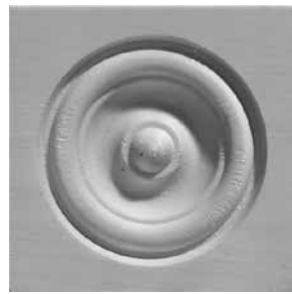

Bullseye Rosette
B 642
5/8 x 2-1/2
WHITE WOOD

B 734
27/32 x 3-1/2
WHITE WOOD

B 740
27/32 x 4-1/2
WHITE WOOD



Bullseye Rosette - Beveled
1400
7/8 x 2-3/4
PRIMED

1402
7/8 x 3-3/4
PRIMED

334
7/8 x 3-3/4
MDF

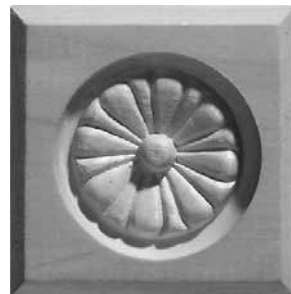

Floral Rosette - Beveled
B 871
1-1/16 x 3-1/2
WHITE WOOD

B 915
27/32 x 2-1/2
WHITE WOOD

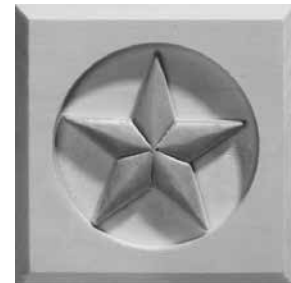

Star Rosette - Beveled
B 1200
1-1/16 x 3-1/2
WHITE WOOD



Plinth Block - Beveled
1401
7/8 x 2-3/4 x 4-1/2
PRIMED

1403
7/8 x 3-3/4 x 6
PRIMED

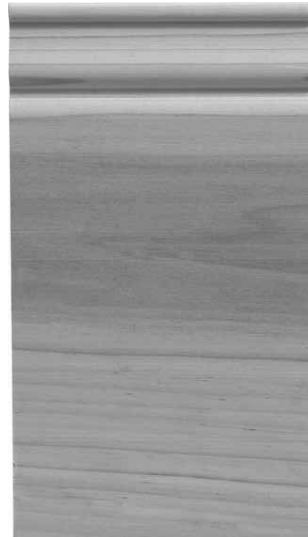

Plinth Block - Moulded
B 887
27/32 x 2-1/2 x 5-3/4
WHITE WOOD

B 742
1-1/16 x 3-1/2 x 6-1/2
WHITE WOOD

334
1 x 3-3/4 x 9
MDF

B 743
1-1/16 x 4-1/2 x 8
WHITE WOOD

Corbels | Base Blocks



C A8 ORCRW
Decorative Corbel
5-1/2 x 4-5/8 x 9-13/16
MAPLE



C A8 ORPWH
Decorative Corbel
5-1/2 x 4-5/8 x 9-13/16
PAINTED WHITE



CA60 ORPWH
Decorative Corbel
9 x 3-1/2 x 12
PAINTED WHITE



C A110 ORMAP
Shelf or Counter Bracket
8 x 3 x 12
MAPLE



CA70 ORMAP
Classic Corbel
6-1/2 x 3 x 12
MAPLE



CA70 ORPWH
Classic Corbel
6-1/2 x 3 x 12
PAINTED WHITE



Base Block - Outside Corner
B 892
1-1/8 x 6-3/4
WHITE WOOD



Base Block - Outside Corner
1892
1-1/8 x 6-1/2
PRIMED



Base Block Inside Corner
B 895
7/8 x 6-3/4
WHITE WOOD



Base Block Inside Corner
1895
1-1/8 x 6-1/2
PRIMED

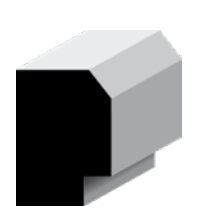

B GC1
Slant Cap
3/4 x 1-1/16
PRIMED 16'

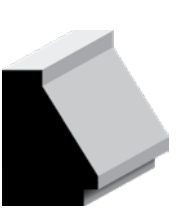

B GC2
Chamfer Cap
3/4 x 1-1/16
PRIMED 16'



L 167
Base Cap
5/8 x 1-1/8
PRIMED 8'
PINE 8'



L 163
Base Cap
5/8 x 1-3/8
PRIMED 8' | 12'



163
Base Cap
11/16 x 1-3/8
MDF 16'
PRIMED 16'
PINE 12' | 16'



8412
Base Cap
5/8 x 1-3/8
PRIMED 16'



8416
Base Cap
5/8 x 1-5/8
PRIMED 16'

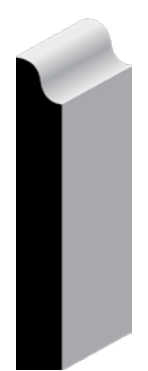

912
3/8 x 2-1/2
PINE 8'



L 634
3/8 x 2-3/4
OAK 8'



L 433 E2E
1/2 x 3-1/4
MDF 16'



L 433E E1E
1/2 x 3-1/4
MDF 8' | 12'
9/16 x 3-1/4
PRIMED 8' | 12'



633
1/2 x 3-1/4
OAK 8' | 12'

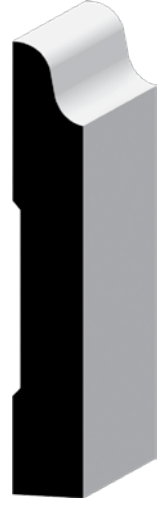

662
9/16 x 3-1/2
PRIMED 8' | 12' | 16'
PINE 8' | 12'



L 414 E1E
9/16 x 4-1/4
PRIMED 8' | 12' | 16'



620
1/2 x 4-1/4
MDF 8' | 12' | 16'
9/16 x 4-1/4
PRIMED 8' | 12' | 16'
PINE 8'



660
9/16 x 4-1/4
PRIMED 8' | 12'



750
9/16 x 4-1/4
PRIMED 16'



623
1/2 x 3-1/4
MDF 8' | 12' | 16'
9/16 x 3-1/4
PRIMED 8' | 10' | 12' | 16'
PINE 8' | 12' | 16'



663
9/16 x 3-1/4
PRIMED 8' | 12' | 16'
PINE 8' | 12'



713
9/16 x 3-1/4
PRIMED 8' | 12' | 16'
PINE 8' | 12' | 16'



753
9/16 x 3-1/4
PRIMED 16'

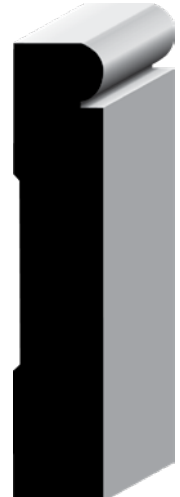

9750
11/16 x 3-1/2
PRIMED 16'



545
19/32 x 5
MDF 16'
5/8 x 5-1/4
PRIMED 16'



163E
19/32 x 5-1/4
MDF 8' | 16'
11/16 x 5-1/4
PRIMED 16'

L 163E
9/16 x 5-1/4
PINE 16'



738
9/16 x 5-1/4
PRIMED 8' | 16'



618
9/16 x 5-1/4
PRIMED 16'



B 312
19/32 x 5-1/4
MDF 16'



750W
9/16 x 5-1/4
PRIMED 16'



L 514 E1E
9/16 x 5-1/4
PRIMED 8' | 12' | 16'



7055
19/32 x 5-1/4
MDF 16'



9243
3/4 x 5-1/4
MDF 8' | 16'



WB514
9/16 x 5-1/4
PRIMED 16'



263
11/16 x 7
MDF 8' | 16'
PRIMED 16'



SCBA
11/16 x 7
PRIMED 16'



STBA
11/16 x 7
PRIMED 16'



207
19/32 x 7-1/4
MDF 16'



7163
19/32 x 7-1/4
MDF 16'



B G712
9/16 x 7-1/2
PRIMED 16'



B G512
9/16 x 5-1/2
PRIMED 16'



512E E1E
1/2 x 5-1/2
MDF 16'

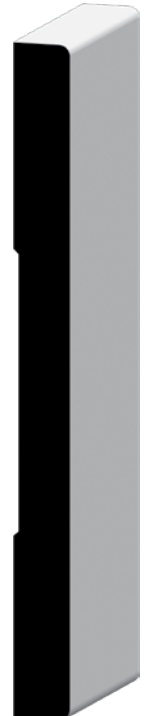

512 E2E
1/2 x 5-1/2
MDF 8' | 12'



5 STBA Step Base
11/16 x 5-1/2
PRIMED 16'



5 SCBA Scoop Base
11/16 x 5-1/2
PRIMED 16'

Crown

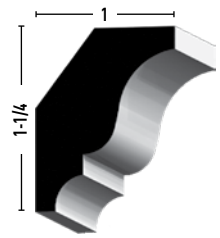

68
9/16 x 1-5/8
PRIMED 8' | 12'

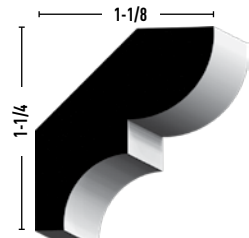

75
9/16 x 1-5/8
PRIMED 8' | 12' | 16'
PINE 8' | 12' | 16'

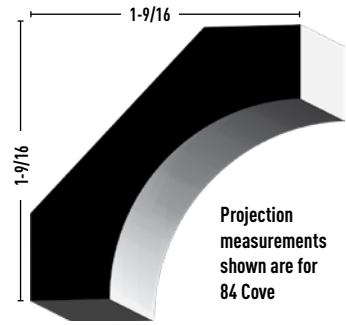

84 Cove
9/16 x 2-1/4
PINE RL

Projection measurements shown are for 84 Cove

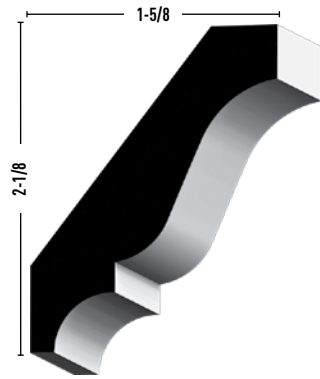

53
9/16 x 2-5/8
PRIMED 8' | 12' | 16'
PINE 16'

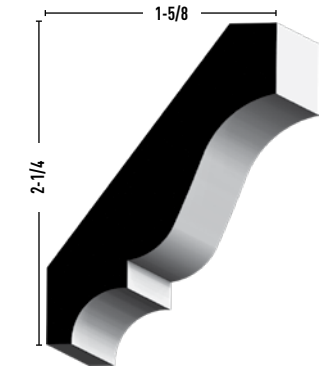

52
9/16 x 2-3/4
PINE 8' | 12'

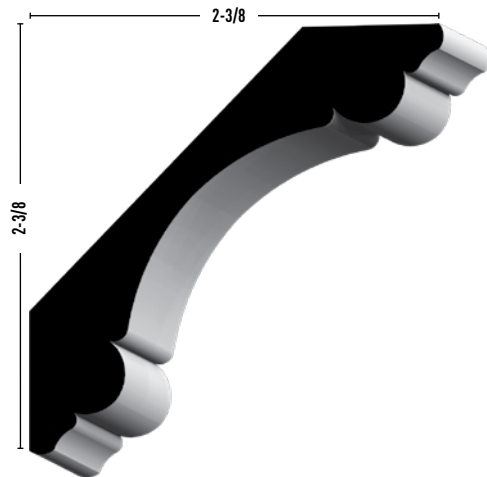

L 340
11/16 x 3-3/8
MDF 8' | 12'

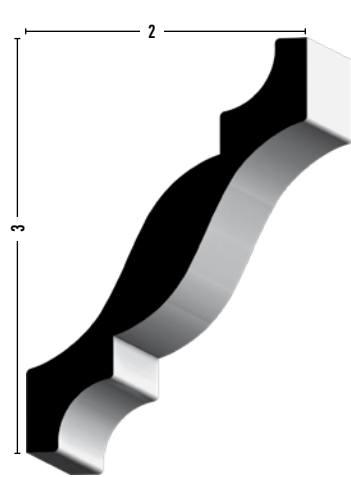

F 49 Flip Face
9/16 x 3-5/8
PRIMED 8' | 12'

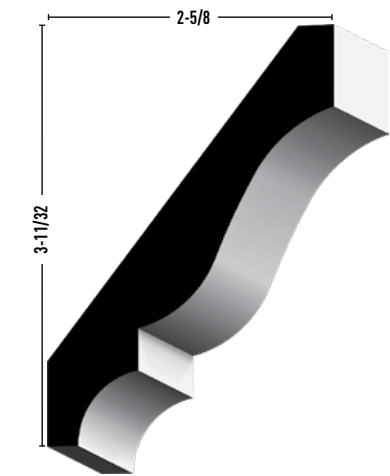

L 49
19/32 x 3-5/8
MDF 16'
9/16 x 3-5/8
PRIMED 8' | 12' | 16'
PINE 8' | 12' | 16'

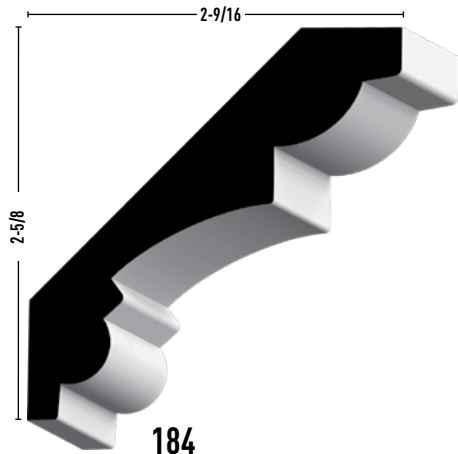

184
3/4 x 3-11/16
MDF 16'

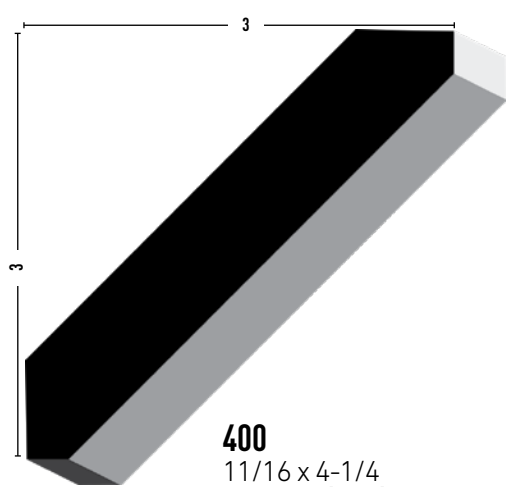

400
11/16 x 4-1/4
MDF 8' | 12' | 16'

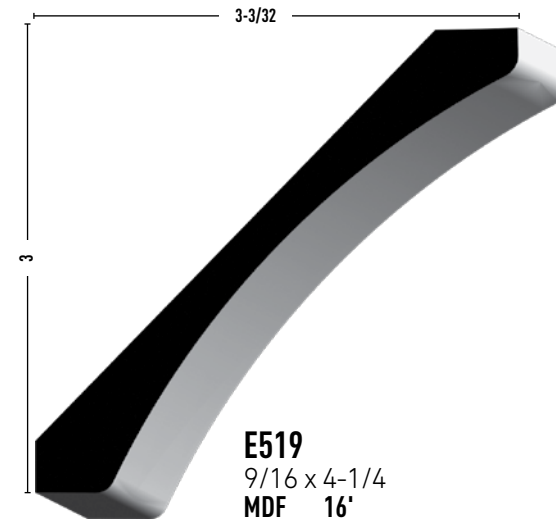

E519
9/16 x 4-1/4
MDF 16'

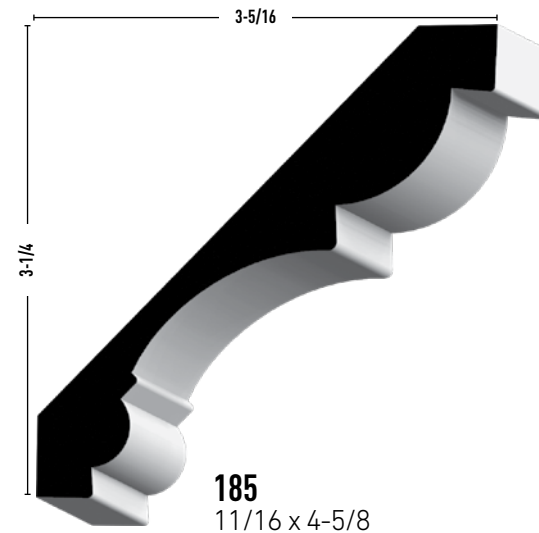

185
11/16 x 4-5/8
MDF 16'

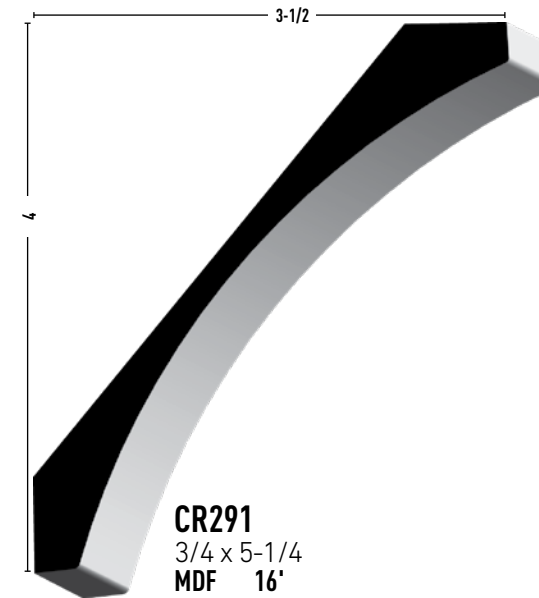

CR291
3/4 x 5-1/4
MDF 16'

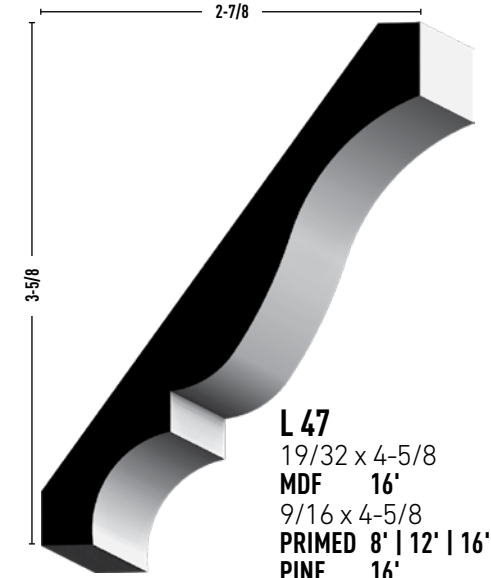

L 47
19/32 x 4-5/8
MDF 16'
9/16 x 4-5/8
PRIMED 8' | 12' | 16'
PINE 16'

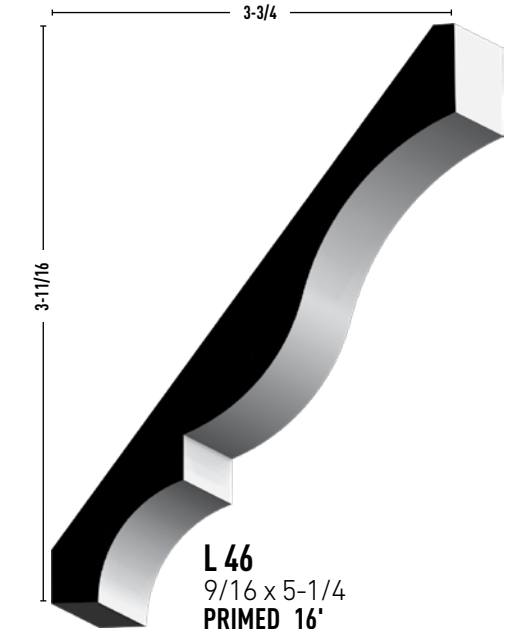

L 46
9/16 x 5-1/4
PRIMED 16'

Crown

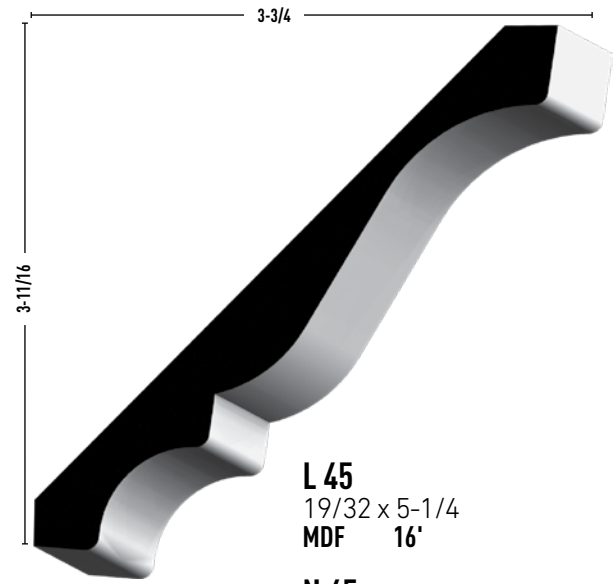

L 45
19/32 x 5-1/4
MDF 16'

N 45
11/16 x 5-1/4
PRIMED 16'

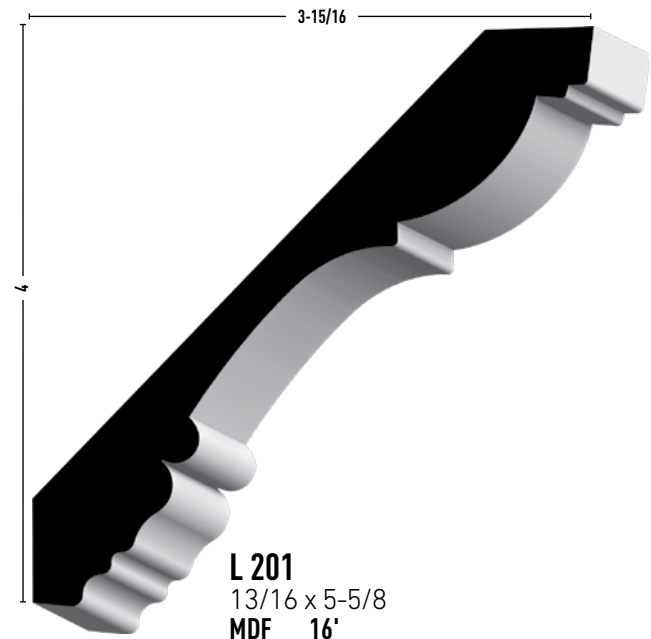

L 201
13/16 x 5-5/8
MDF 16'

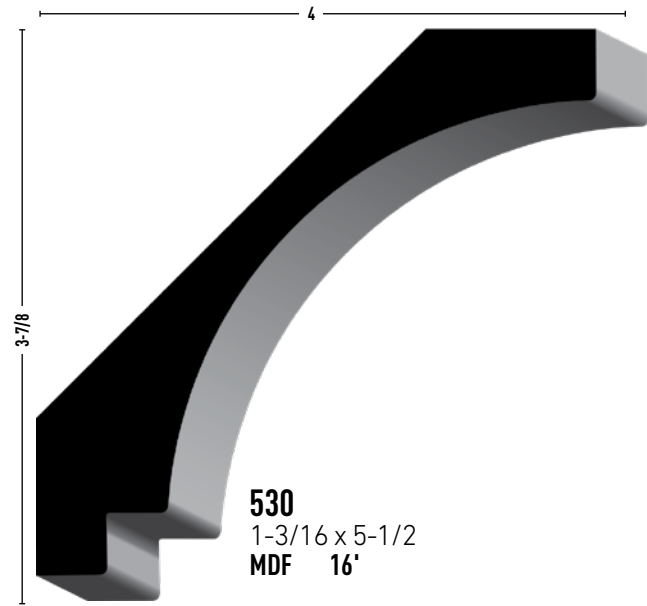

530
1-3/16 x 5-1/2
MDF 16'

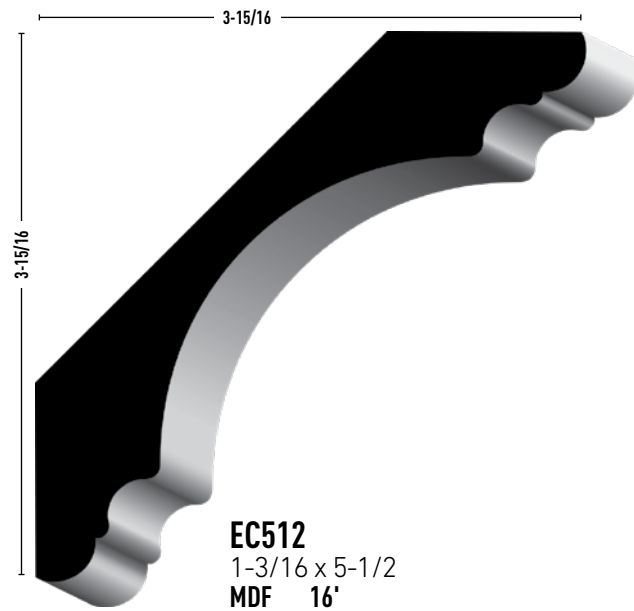

EC512
1-3/16 x 5-1/2
MDF 16'

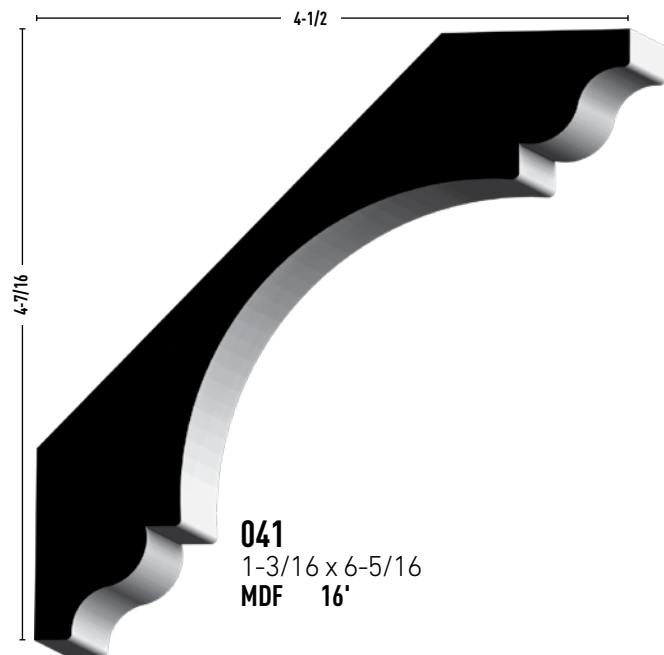

041
1-3/16 x 6-5/16
MDF 16'

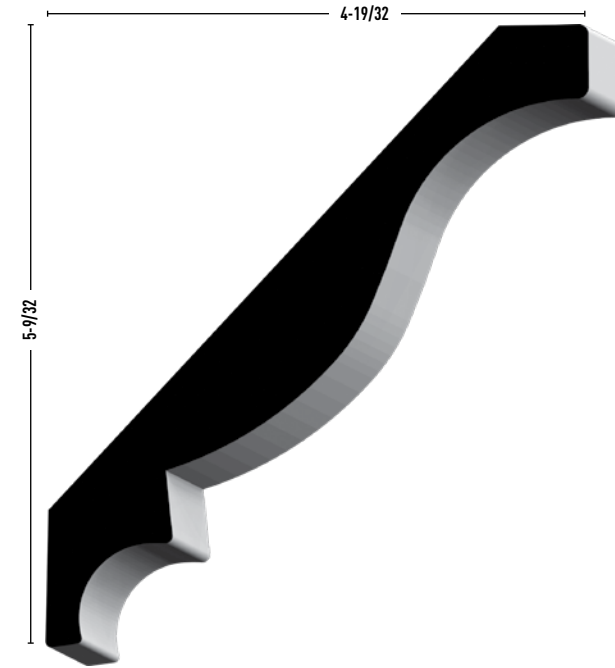

043
1 x 6-15/16
MDF 16'

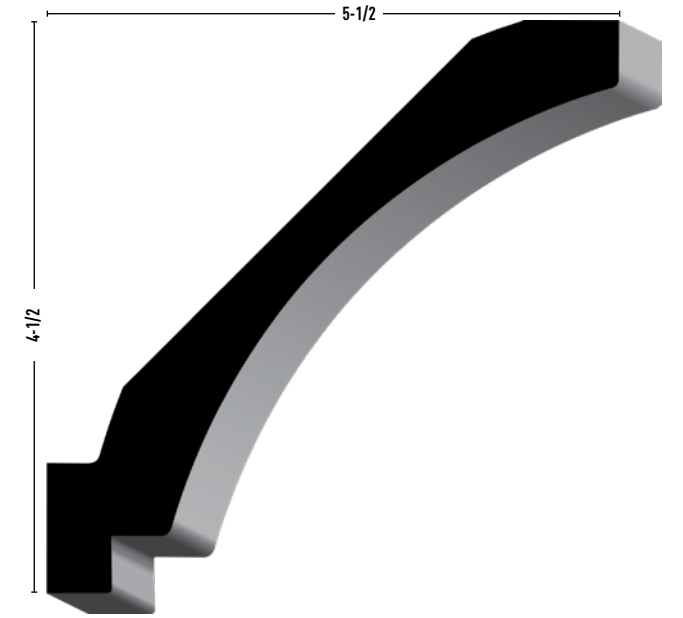

730
1-3/16 x 7
MDF 16'

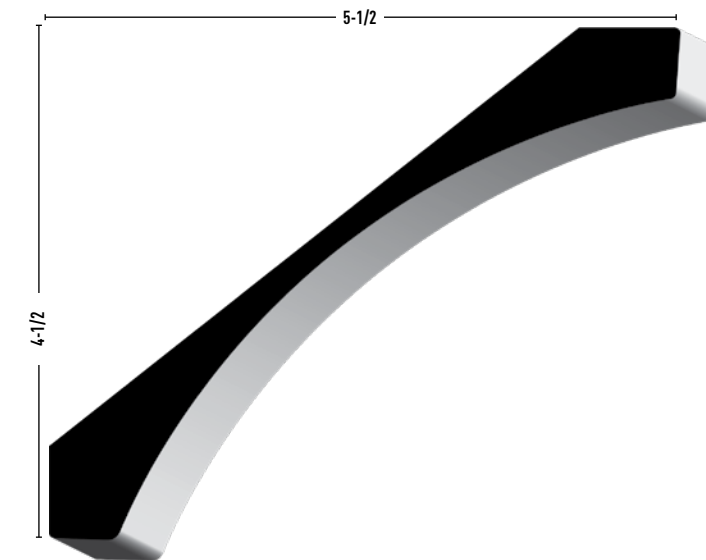

505
1 x 7
MDF 16'

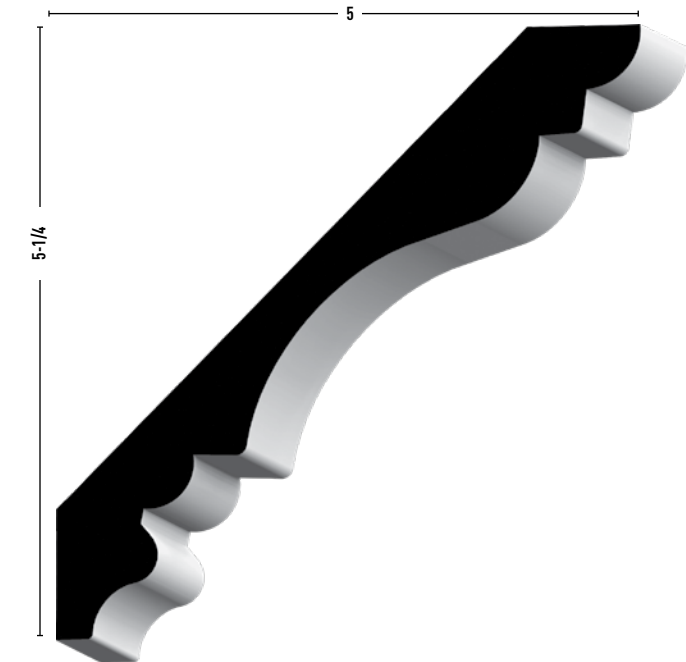

721
1 x 7-1/4
MDF 16'

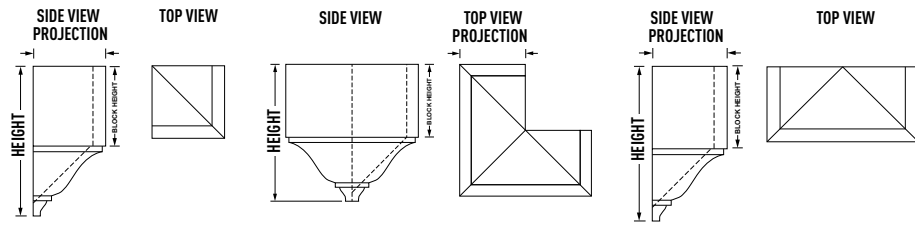

**Inside Corner
1889 - Large**
3-1/2 x 3-1/2 x 7-1/2
PINE



**Outside Corner
1889 - Large**
7-1/2 x 10 x 8
PINE

Inside Corner	Middle	Outside Corner
1897 - Small 2-3/8 x 2-1/64 x 4-1/8 WHITE WOOD	1888 - Medium 2-5/8 x 5-1/2 x 5-5/8 PRIMED	1897 - Small 2-3/8 x 2-1/64 x 4-1/8 WHITE WOOD
1888 - Medium 2-5/8 x 2-5/8 x 5-5/8 PINE PRIMED	1888 - Medium 2-5/8 x 5-1/2 x 5-5/8 PRIMED	1888 - Medium 5-5/8 x 7-3/4 x 6-1/4 PINE PRIMED
1898 - Medium 3-1/8 x 2-27/32 x 5-7/8 WHITE WOOD		
1899 - Large 4-3/16 x 3-11/16 x 7-3/4 WHITE WOOD		



1195
11/16 x 2-1/2
PINE 8'



6 1021
19/32 x 6-1/2
MDF 16'

7 1021
19/32 x 7-1/4
MDF 16'
11/16 x 7-1/4
PRIMED 16'



1021
11/16 x 5-1/4
MDF 16'
PRIMED 8' | 16'



4 1021
11/16 x 4-1/2
PRIMED 16'



S 1196 Extension Jamb
11/16 x 2
MDF 16'
11/16 x 2
PRIMED 16'



358 Threshold
5/8 x 3-5/8
OAK 37" | 73"



458 Threshold
5/8 x 4-5/8
OAK 37" | 73"



1163
1-1/16 x 3-1/4
PINE 8'

Window & Door Miscellaneous



1305 T-Astragal
1-1/4 x 2
PRIMED 7' | 8'

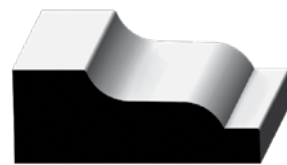

L 210 Shingle Mould
5/8 x 1-5/8
PRIMED 8' | 12' | 16'

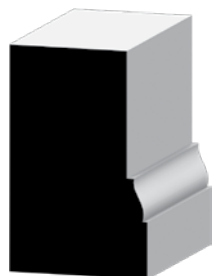

180 Brick Mould
1-1/4 x 2
PRIMED 7' | 10' | 17'
PVC 18'



133 Flat Astragal
11/16 x 1-3/4
PRIMED 16'

Stops



888 E1E
3/8 x 1-1/8
PRIMED 7'



L 878 E2E
7/16 x 1-1/8
PRIMED 8'3"



876 E1E
7/16 x 1-3/8
PRIMED 16'



865 E1E
1/2 x 1-5/8
PRIMED 8'3"



857
3/8 x 1-1/4
PINE 7'



L 888 E2E
3/8 x 1-1/8
PRIMED 6'8" | 7'



886 E1E
3/8 x 1-3/8
PRIMED 7' | 16'
PINE 7'

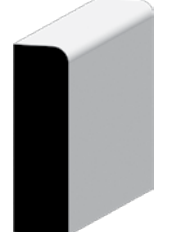

887 E1E
3/8 x 1-1/4
MDF 7'



951
3/8 x 3/4
PINE 7' | 8' | 10'

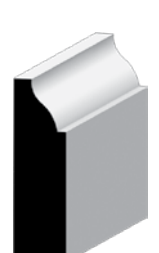

947
3/8 x 1-1/4
PRIMED 7' | 16'
OAK 7'
PINE 7' | 10'



946
3/8 x 1-3/8
PRIMED 7' | 16'
PINE 7' | 10'
MDF 7'



L 936
7/16 x 1-3/8
PRIMED 8'3"



936
7/16 x 1-3/8
PRIMED 7' | 16'
PINE 7'



925
1/2 x 1-5/8
PRIMED 8'3"

Mullions



L 887 E2E
3/8 x 1-1/4
OAK 7'
PINE 7'



984
3/8 x 1-3/8
PINE 16'



L 983
3/8 x 1-5/8
PINE 8'



958
3/8 x 1-1/2
PINE 8'



956
3/8 x 2
PINE 8'

Panel Mould | Ply Caps



8578 Nosing
11/16 x 1-1/8
PRIMED 16'



183 Panel Mould
9/16 x 1-1/8
PINE RL



L 184 Panel Mould
1/2 x 1-1/2
PRIMED 16'

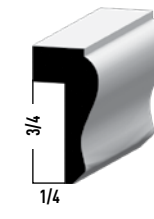

292 Ply Cap
9/16 x 1-1/8
PINE 8'

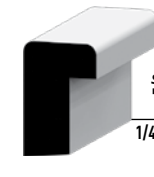

280 Back Band
11/16 x 1-1/8
PRIMED 16'

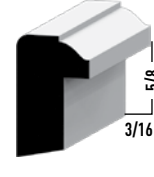

281 Back Band
11/16 x 1-1/8
PRIMED 16'
PINE 8'



L CAP EC
1-3/8 x 1-3/4
PRIMED 16'



L WCAP Wainscot Cap
11/16 x 2
MDF 8'



1219 Ply Cap
11/16 x 1-5/8
PINE 8'



B G200 Bevel Nose Back Band
1-1/16 x 1-1/16
PRIMED 16'



B G250 Eased Nose Back Band
1-1/16 x 1-1/16
PRIMED 16'

Chair Rails



L 390 Chair Rail
9/16 x 2-5/8
MDF 12'



297 Chair Rail
19/32 x 3
MDF 16'
11/16 x 3
PRIMED 16'
PINE 16'



300 Chair Rail
1 x 3
MDF 16'
1-1/16 x 3
PRIMED 8' | 12' | 16'



956W Backer Bead
1/2 x 4-1/4
MDF 16'



L 956W Backer Bead
7/16 x 4-1/4
PRIMED 8' | 16'

Miscellaneous



126 Shoe
1/2 x 3/4
PRIMED 12' | 16'
OAK 8' | RL
PINE 12' | 16'

129

7/16 x 11/16
PRIMED 8' | 12'
PINE 8' | 12'

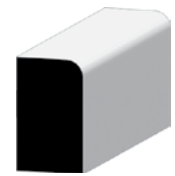

L 254 Craftsman Shoe
7/16 x 3/4
PRIMED 8' | 12' | 16'



131 Ogee Shoe
1/2 x 3/4
PRIMED 16'



B G100 Shoe
5/8 x 1
PRIMED 16'



995 Chamfer
3/4 x 3/4
PINE 8' | RL



E 1035 Extension Half Round
1/2 x 1-3/8
MDF 8'



103 Quarter Round
1-1/16 x 1-1/16
PINE RL

105

3/4 x 3/4
OAK 8'
PINE 8' | RL

106

11/16 x 11/16
PRIMED 8' | 12' | 16'
PINE 8' | 12' | 16'

108

1/2 x 1/2
PINE 8' | 16'



122 Half Round
3/8 x 11/16
PINE 8'

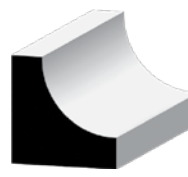

93 Cove
3/4 x 3/4
OAK 8'

100

11/16 x 11/16
PRIMED 8' | 16'
OAK RL
PINE 8' | 16'

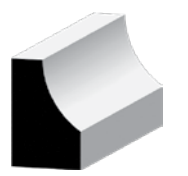

1075 Scotia
1/2 x 3/4
OAK RL

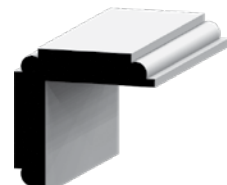

202 Corner Guard
1-1/8 x 1-1/8
PINE 8'

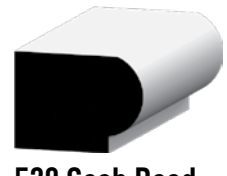

520 Sash Bead
5/8 x 13/16
PRIMED 16'

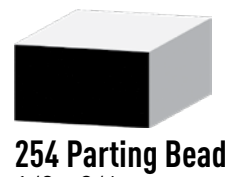

254 Parting Bead
1/2 x 3/4
PRIMED 16'
PINE 8' | 16'



144 Beaded Screen Mould
1/4 x 3/4
PINE 8'

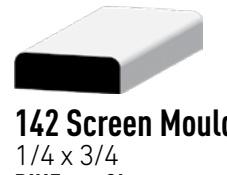

142 Screen Mould
1/4 x 3/4
PINE 8'



2 Extension Mullion
1-1/4 x 2
PRIMED 7'

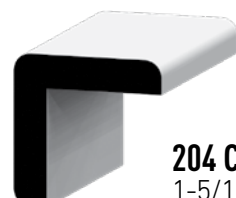

204 Corner Guard
1-5/16 x 1-5/16
PINE 8'

205

1-1/16 x 1-1/16
OAK 8'
1-1/8 x 1-1/8
PRIMED 8'
PINE 8'

206

3/4 x 3/4
PINE 8'



5 263 Lattice
1/4 x 5-1/4
PINE RL

W 266

1/4 x 1-5/8
PINE 8'

L 266

1/4 x 1-1/2
PRIMED 8'
PINE 8' | 10' | RL

L 267

1/4 x 1-3/8
PINE 8' | 16'

L 268

1/4 x 1-1/8
PINE 8' | RL



L 249 Screen Stock
1/2 x 1-5/8
PINE 8'
L 247
1/2 x 2
PINE 8'

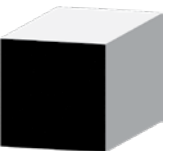

239
3/4 x 3/4
PINE 8'

Wall Rails

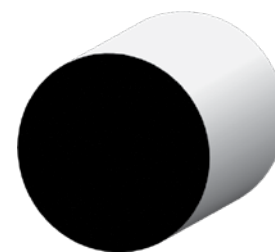

L 232 Closet Pole
1-1/2 Full Round
SPINE 8'

L 233

1-1/4 Full Round
SPINE 8'
DFIR RL (Short Supply)
Laminated Veneer Lumber
LVLBA 16' (Discontinued)

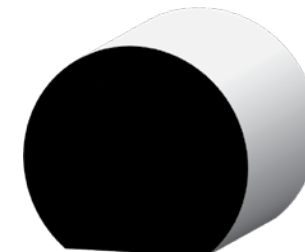

231 Wall Rail
1-1/2 x 1-11/16
DFIR 8' | 12' (Short Supply)
SPINE 8' | 12' | 16'

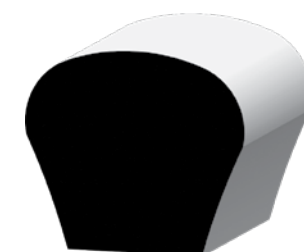

230 Wall Rail
1-1/2 x 1-11/16
SPINE 16'



240 Wall Rail
1-1/4 x 2-1/4
SPINE 8' | 12' | 16'
PRIMED 16'

Wall Panels



SL18 Tongue & Groove Shiplap
11/16 x 7-1/4
MDF 16'



SL18 Nickel Gap Shiplap
5/8 x 7-1/2
PRIMED 16'



L CAP EC
1-3/8 x 1-3/4
PRIMED 16'
Use with ECB product



1X6 EC Wainscoting
23/32 x 5-1/2
PRIMED 16'



SL16 Tongue & Groove Shiplap
11/16 x 5-1/4
MDF 16'

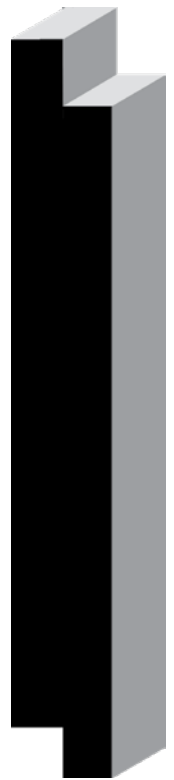

SL16 Nickel Gap Shiplap
5/8 x 5-1/2
PRIMED 16'



In-Stock and available for Quick Ship
(Call and Check availability)

More styles and innovative stair
products available for
special order at:
LJSMITH.COM



**NORTHEAST DISTRIBUTION CENTER
STOCKED STAIR PARTS**

Hand Rail Construction

A Hand Rail is made
of layers,
also known as plys.

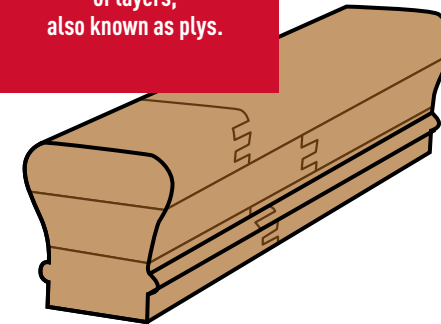

Finger joints
on all plys

Finger Joint Hand Rail

- All plys utilize finger joint construction.
- Top plys are color matched in 42" lengths and longer.
- Bottom plys contain multiple finger joints.
- Rail is made with two or more plys

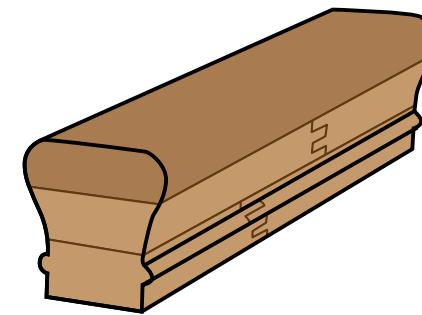

Top ply is
free of finger
joints*

Solid Cap Hand Rail

- *The top ply will be free of finger joints. Butt joints on top ply (cap) will vary by specie.
- Bottom two plys utilize finger joint construction.

Engineered hand rail
consists of core filler
pieces that are wrapped
in the profile of the hand rail. As
such, engineered hand rail has
SIDES instead of PLYS.

Solid wood top, sides and bottom

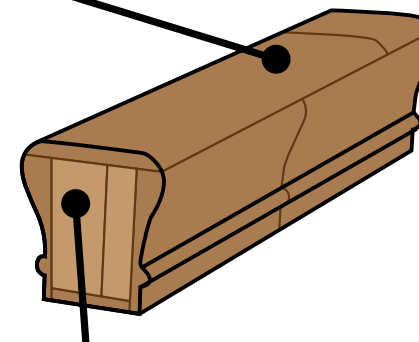

Like specie filler pieces inside

Butt
joints
instead of
finger joints

Engineered Hand Rail

- Constructed using butt joints instead of finger joints.
- Solid wood filler pieces wrapped in profiled finish wood pieces.

Rail Length	Oak	
	Top Joints	Sides
6-8' Rail	0	1-2
10-12' Rail	0	2-3
13-16' Rail	1	3-5
18-20' Rail	2	3-6
Bottom (all sizes)- unlimited joints		

Hand Rail

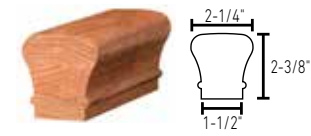

EMPIRE SKU #	LJ SKU #	(L')s
6010 BEECH	LJAN-6010-B	8, 10, 12, 14, 16
6010 OAK	LJAN-6010-O	8, 10, 12, 14, 16, 18, 20
6010 OAKSC	LJAN-6010SC-O	8, 10, 12, 14, 16
6010 WOKSC	LJAN-6010SC-WO	8, 10, 12, 14, 16
6010 EOAK	LJAN-6010U-O	6, 8, 10, 12, 14, 16, 20
6010 POPLR	LJAN-6010-P	8, 12, 16
6010 EPOP	LJAN-6010UJ-P	8, 12, 16

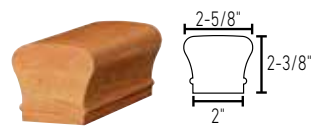

EMPIRE SKU #	LJ SKU #	(L')s
6210 OAK	LJAN-6210-O	8, 10, 12, 14, 16
6210 OAKSC	LJAN-6210SC-O	8, 10, 12, 14, 16
6210 WOKSC	LJAN-6210SC-WO	8, 10, 12, 14, 16
6210 EPOP	LJAN-6210UJ-P	8, 12, 16

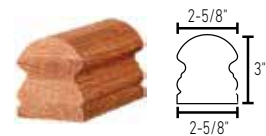

EMPIRE SKU #	LJ SKU #	(L')s
6519 OAK	LJAN-6519-O	8, 12, 16

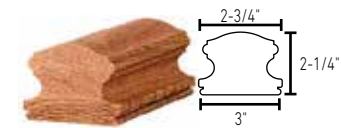

EMPIRE SKU #	LJ SKU #	(L')s
6002 OAK	LJAN-6002-O	8, 10, 12, 16
6002 WOKSC	LJAN-6002-WO	8, 10, 12, 16
6002 POPLR	LJAN-6002-P	8, 12, 16

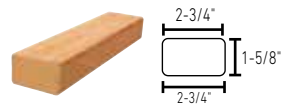

EMPIRE SKU #	LJ SKU #	(L')s
6002 OAK	LJAN-6002-O	8, 10, 12, 16
6002 WOKSC	LJAN-6002-WO	8, 10, 12, 16
6002 POPLR	LJAN-6002-P	8, 12, 16



EMPIRE SKU #	LJ SKU #	(L')s
684 OAK	AN684-O	16

Plowed Hand Rail

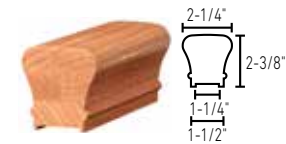

EMPIRE SKU #	LJ SKU #	(L')s
P6010 OAK	LJAN-6010P/6000F-O	8, 12, 14, 16
P6010 WOKSC	LJAN-6010PS/6000F-WO	12, 16
P6010 EOAK	LJAN-6010PU/6000F-O	8, 10, 12, 14, 16
P6010 POPLR	LJAN-6010P/6000F-P	8, 12, 16
P6010 EPOP	LJAN-6010PUJ/6000F-P	8, 12, 16

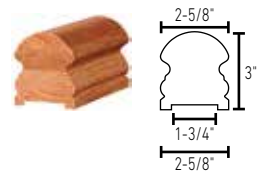

EMPIRE SKU #	LJ SKU #	(L')s
P6519 OAK	LJAN-6519P/6007-O	8, 16

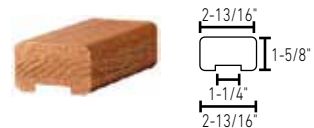

EMPIRE SKU #	LJ SKU #	(L')s
P6000 OAK	LJAN-6000/6000F-O	8, 10, 12, 16
P6000 WOKSC	LJAN-6000/6000F-WO	12, 16
P6000 POPLR	LJAN-6000/6000F-P	8, 12, 16

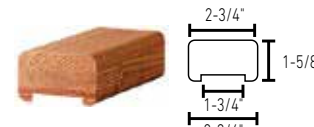

EMPIRE SKU #	LJ SKU #	(L')s
P6001 OAK	LJAN-6001/6007-O	8, 16
P6001 POPLR	LJAN-6001/6007-P	8, 12, 14, 16

Shoe Rail

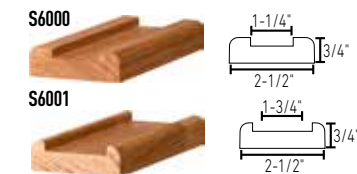

EMPIRE SKU #	LJ SKU #	(L')s
S6000 OAK	LJAN-6000S/6000F-O	8, 12, 16
S6000 POPLR	LJAN-6000S/6000F-P	8, 12, 16
S6001 OAK	LJAN-6001S/6007-P	8, 10, 12, 16
S6001 POPLR	LJAN-6001S/6007-P	8, 12, 16
P6045 OAK	LJAN-6045/6000F-O	8, 10, 12, 16
P6045 POPLR	LJAN-6045/6000F-P	8, 10, 12, 14, 16

Fillet

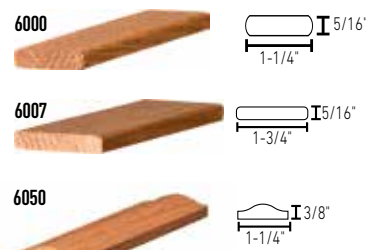

EMPIRE SKU #	LJ SKU #	(L')s
6000 LF OAK	LJ-6000-O	LF
6000 LF POPLR	LJ-6000-P	LF
6007 LF OAK	LJ-6007-O	LF
6007 LF POPLR	LJ-6007-P	LF
6050 LF OAK	LJ-6050-O	LF
6050 LF POPLR	LJ-6050-P	LF

Bending Rail



EMPIRE SKU #	LJ SKU #	(L')s
B6010 OAK	LJAN-6010B-O	8, 16

Wall Rail

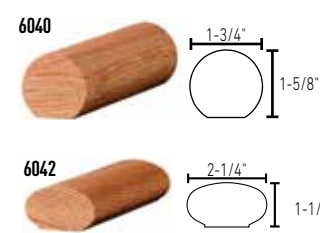

EMPIRE SKU #	LJ SKU #	(L')s
6040 OAK	LJAN-6040-O	16
6042 OAK	LJAN-6042-O	8, 14, 16

Fittings match 6010 handrail profile
7211, 7212, 7214 match 6210 profile

Fittings | Caps | Stair Misc.

4° Return End, Starting Easing with Cap, 90° Level Quarter Turn, 60° Up Easing, 60° Over Easing, 90° Up Easing

EMPIRE SKU #	LJ SKU #	EMPIRE SKU #	LJ SKU #	EMPIRE SKU #	LJ SKU #	EMPIRE SKU #	LJ SKU #	EMPIRE SKU #	LJ SKU #
7009 OAK	S-7009-O	7010 OAK	S-7010-O	7011 OAK	S-7011-O	7012 OAK	S-7012-O	7013 OAK	S-7013-O
				7011 WOKSC	S-7011-WO	7012 WOKSC	S-7012-WO		
				7211 OAK	S-7211-O	7212 OAK	S-7212-O		
				7211 WOKSC	S-7211-WO	7212 WOKSC	S-7212-WO	7014 OAK	S-7014-O
								7014 WOKSC	S-7014-WO
								7214 OAK	S-7214-O

Opening Cap, Tandem Cap, 90° Level Quarter Turn with Cap, 135° Level Turn with Cap, Left-hand Offset Rail, Right-hand Offset Rail

EMPIRE SKU #	LJ SKU #	EMPIRE SKU #	LJ SKU #	EMPIRE SKU #	LJ SKU #	EMPIRE SKU #	LJ SKU #
7019 OAK	S-7019-O	7020 OAK	S-7020-O	7021 OAK	S-7021-O	7021 13 OAK	S-7021-135-O
						7047 OAK	LJ-7047-O (LH)
						7048 OAK	LJ-7048-O (RH)

Goosenecks

Newel, Newel

Left-hand 2 Riser With Cap, Right-hand 2 Riser With Cap, Left-hand 2 Riser With Cap, Right-hand 2 Riser With Cap, 7088-2 2 Rise with Tandem Cap, 7099 2 Rise No Cap Post to Post Application

EMPIRE SKU #	LJ SKU #	EMPIRE SKU #	LJ SKU #	EMPIRE SKU #	LJ SKU #	EMPIRE SKU #	LJ SKU #
7081 OAK	S-7081-O (LH)	7086 OAK	S-7086-O (RH)	7060 OAK	S-7060-O (LH)	7065 OAK	S-7065-O (RH)
				7088-2 OAK	S-7088-2-O	7099 OAK	S-7099-O

Volutes and Turnouts

Left-hand Volute, Right-hand Volute, 5° Left-hand Turnout, 5° Right-hand Turnout

EMPIRE SKU #	LJ SKU #	EMPIRE SKU #	LJ SKU #	EMPIRE SKU #	LJ SKU #
7030 OAK	S-7030-O (LH)	7040 OAK	S-7040-O (LH)	7045 OAK	S-7045-O (RH)
7035 OAK	S-7035-O (RH)				

Stair Misc.

Baluster Pin, 7028 Tread Bracket, 7029 Tread Bracket

EMPIRE SKU #	LJ SKU #	EMPIRE SKU #	LJ SKU #
7028 OAK	LJ-7028-O	7029 OAK	LJ-7029-O
7028 POPLR	LJ-7028-P		

False Treads/Nosing

8010-2 False End Starting Step Cove and Shoe Included, 8090 Landing Tread, 8079 False Tread Kit, 8080 13 Lineal Nosing

EMPIRE SKU #	LJ SKU #	(W) X (L)	EMPIRE SKU #	LJ SKU #
8090 LF OAK	LJ-8090-O	3-1/2" X LF	8010-2 OAK	LJ-8010-2-O
8090 LF YPINE	8090-YP	3-1/2" X LF	8079 OAK	LJ-8079-O
5 8090 16 OAK	LJ-8090-5-16-O	5-1/4" X 16"		
5 8090 LF OAK	LJ-8090-5-O	5-1/4" X LF	8080 13 OAK	LJ-8080-13-O

Rosettes

Oval Rosette, Round Rosette

EMPIRE SKU #	LJ SKU #	EMPIRE SKU #	LJ SKU #
7027 OAK	LJ-7027-O	7026 OAK	LJ-7026-O
7027 POPLR	LJ-7027-P		
7037 OAK	LJ-7037-O		
7037 WOKSC	LJ-7037-WO		

Wall Rail Fitting

90° Quarter Turn, Rectangle Rosette

EMPIRE SKU #	LJ SKU #	EMPIRE SKU #	LJ SKU #
7023 OAK	LJ-7023-O	7033 OAK	LJ-7033-O



Stair Treads
1-1/32" x 10-1/2" or 11-1/2"

EMPIRE SKU #	LJ SKU #	(W)" options
<i>Finish skus with (w) value required (i.e. 1036 OAK) for 36"</i>		
10 (W) OAK	807010X(W)	36, 42, 48
10 (W) OAKCL	807010X(W) CL	36, 42, 48, 60
11 (W) OAK	807011X(W)	36, 42, 48, 54, 60
11 (W) OAKCL	807011X(W) CL	36, 42, 48, 60, 96
11 (W) WOAK	807011X(W)-WO	42, 48, 54, 60
12 (W) OAK	807011X(W)	42, 48
B5412 LF OAKSL	807011XRL (500 - MINI-PACK ONLY)	1-1/16" X 11" X 6' TO 12'
31148 OAK	807311X48	3/4" X 11" X 48"

Reversible Miter Return Treads
8070MR1
1-1/32" x 10-1/2" or 11-1/2"

8070LH or 8070RH
(LH - left hand mitered return)
(RH - right hand mitered return)
1-1/32" x 10-1/2", 11-1/2" or 12-1/2"



EMPIRE SKU #	LJ SKU #	(W)" options
<i>Finish skus with (w) value required (i.e. M 1042 OAKCL) for 42"</i>		
M 1048 OAK	807010X481RV	
L 10 (W) OAK	807010X(W) LH	42, 48, 54
R 10 (W) OAK	807010X(W) RH	42, 48, 54
M 10 (W) OAKCL	807010X(W)1RV CL	42, 48, 60
M 11 (W) OAK	807011X(W)1RV	42, 48, 60
M 11 (W) OAKCL	807011X(W)1RV CL	48, 60
L 11 (W) WLOAK	807011X(W) LH	45, 48
R 11 (W) WLOAK	807011X(W) RH	45, 48
L 1148 WLWOK	807011X48LH-WO	
R 1148 WLWOK	807011X48RH-WO	
L 1248 WLOAK	807012X48LH	
R 1248 WLOAK	807012X48RH	



RETROTREAD®

RetroTread
5/8" x 11-1/2"

EMPIRE SKU #	LJ SKU #
1136 OAKRT	8070RETRO-OA-36
1142 OAKRT	8070RETRO-OA-42
1148 OAKRT	8070RETRO-OA-48
1148 WOKRT	8070RETRO-WO-48
1148 MAPRT	8070RETRO-MP-48

Installs over existing stairs, making it easy to upgrade from carpet to premium hardwood



RetroTread®
Reversible Return Nosing
1" x 1-7/8" x 14-3/4"

EMPIRE SKU #	LJ SKU #
NSNG MAPRT	8081RETRO-MP
NSNG OAKRT	8081RETRO-OA
NSNG WOKRT	8081RETRO-WO



RetroRiser®
11/32" x 7-1/2" or 8-1/4"

EMPIRE SKU #	LJ SKU #
7D48 OAKRT	LJRT80757X48
7D42 PMPRT	LJRT80757X42-PR
7D48 PMPRT	LJRT80757X48-PR

Risers
3/4" x 7-1/2" or 8-1/4"

EMPIRE SKU #	LJ SKU #
7D36 OAK	LJ80757X36
7D42 OAK	LJ80757X42
7D48 OAK	LJ80757X48
8D36 PRIMD	LJ80758X36-PR
8D42 PRIMD	LJ80758X42-PR
8D48 PRIMD	LJ80758X48-PR
8D54 PRIMD	LJ80758X54-PR
8D60 PRIMD	LJ80758X60-PR



Reversible Starting Step
8010
10-1/2" x 48", 60" or 72"
OAK

EMPIRE SKU #	LJ SKU #
8010 48 OAK	LJ-8010-0 48

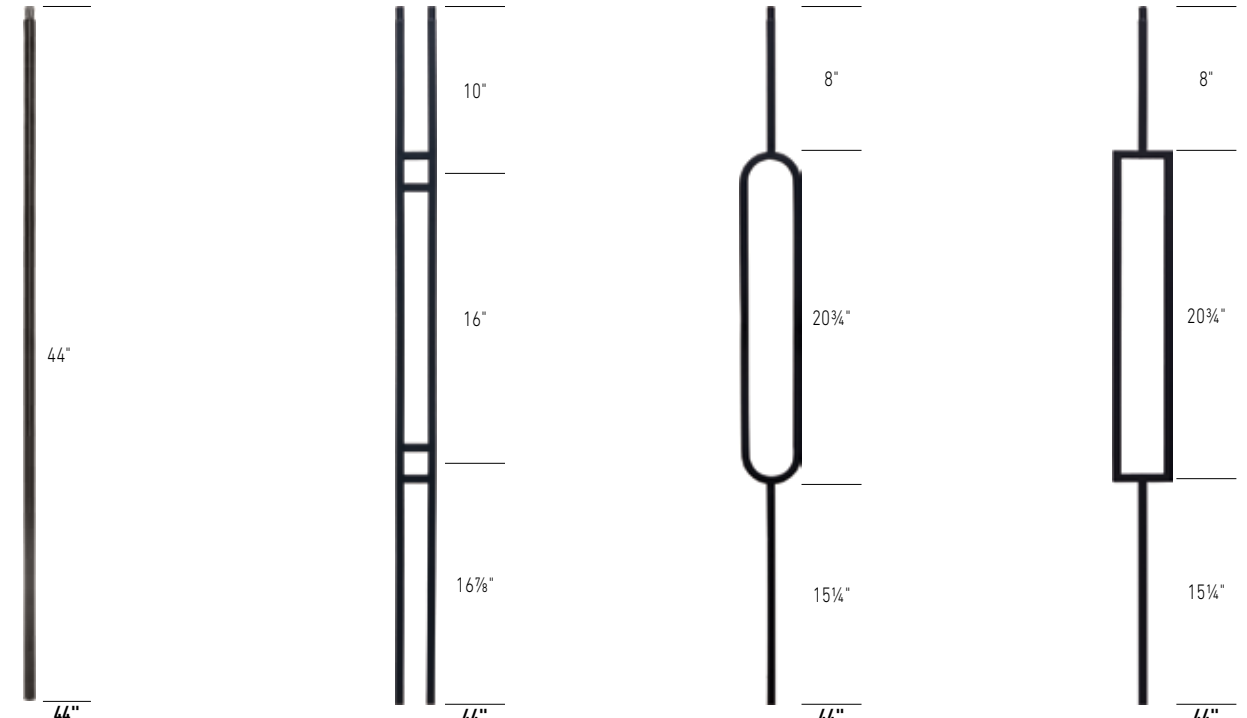
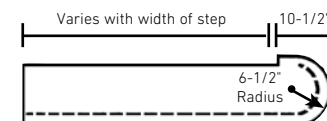

EMPIRE SKU #	LJ SKU #
M PLA 44 HIRON	LIH-HOLPLA44-LSB
Z PLA 44 HIRON	LIH-HOLPLA44-ORB
R PLA 44 HIRON	LIH-HOLPLA44-ORC
M 1661 44 HIRON	LIH-HOL166144-LSB
N 1661 44 HIRON	LIH-HOL166144-MN
M 1662 44 HIRON	LIH-HOL166244-LSB
N 1662 44 HIRON	LIH-HOL166244-MN
M 1663 44 HIRON	LIH-HOL166344-LSB
N 1663 44 HIRON	LIH-HOL166344-MN

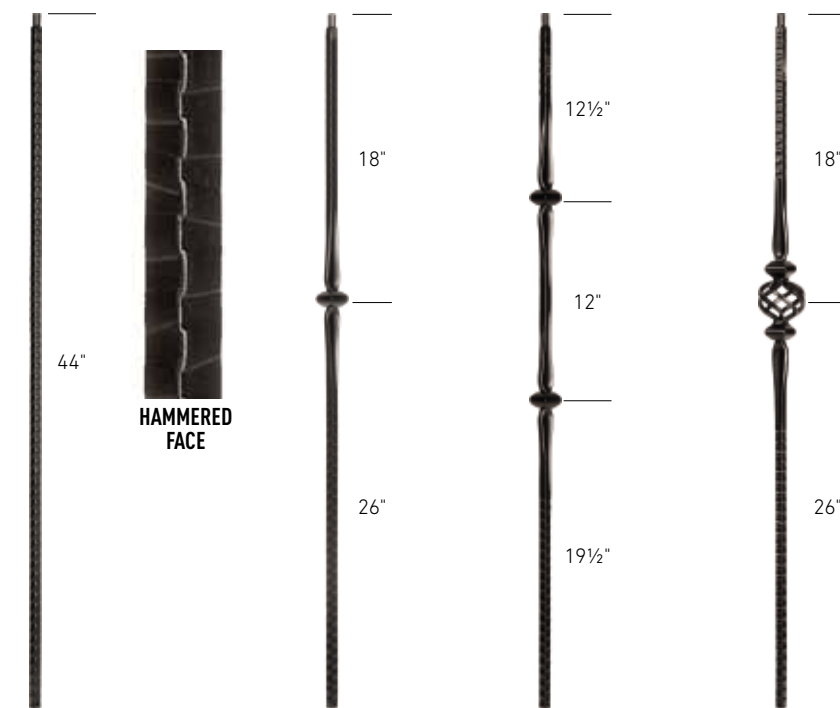

EMPIRE SKU #	LJ SKU #
M 143 44 HIRON	LIH-HOL14344-LSB
M 150 44 HIRON	LIH-HOL15044-LSB
M 140 44 HIRON	LIH-HOL14044-LSB
M 160 44 HIRON	LIH-HOL16044-LSB

Iron Finishes



Denoted by the letter in front of the EMPIRE SKU #

Iron Balusters

■ Solid Square □ Hollow Square

■ Solid Square □ Hollow Square

Iron Balusters

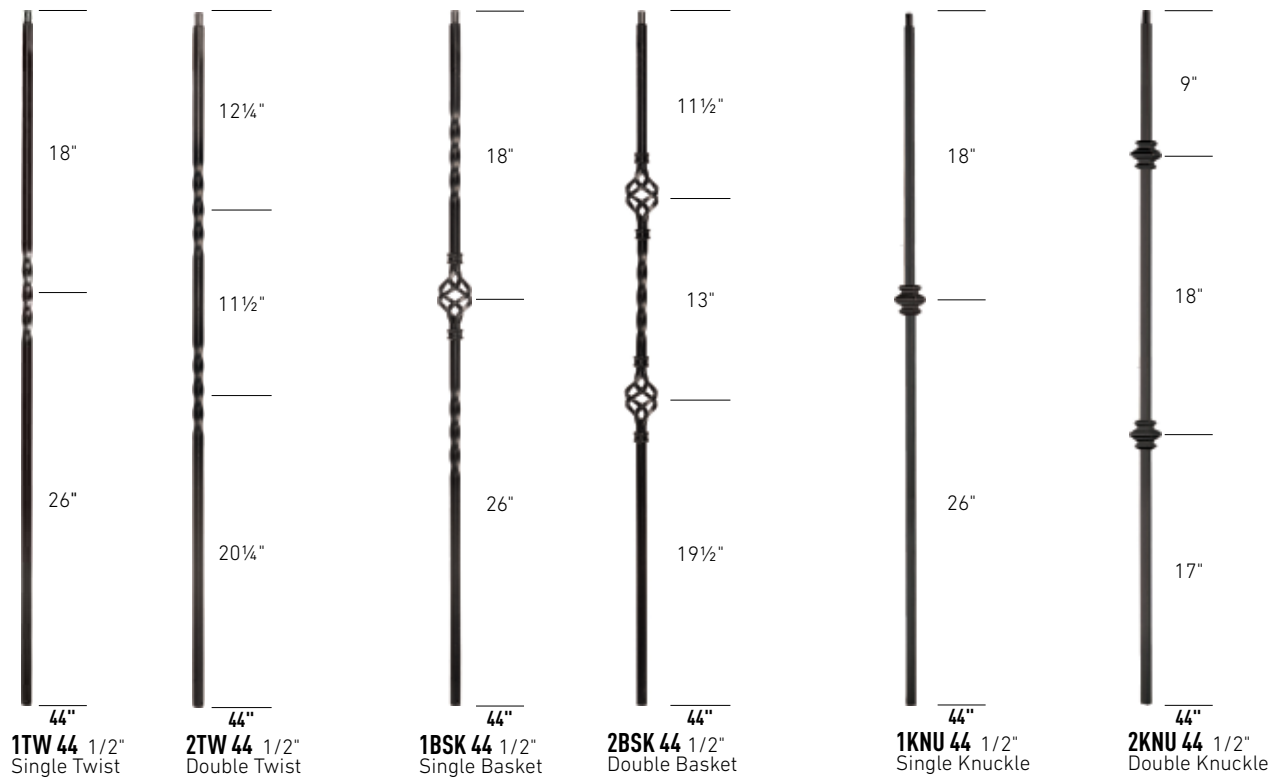

EMPIRE SKU #	LJ SKU #
M 1TW 44 HIRON □	LIH-HOL1TW44-LSB
Z 1TW 44 HIRON □	LIH-HOL1TW44-ORB
R 1TW 44 HIRON □	LIH-HOL1TW44-ORC
M 2TW 44 HIRON □	LIH-HOL2TW44-LSB
Z 2TW 44 HIRON □	LIH-HOL2TW44-ORB
R 2TW 44 HIRON □	LIH-HOL2TW44-ORC

EMPIRE SKU #	LJ SKU #
M 1BSK 44 HIRON □	LIH-HOL1BASK44-LSB
Z 1BSK 44 HIRON □	LIH-HOL1BASK44-ORB
R 1BSK 44 HIRON □	LIH-HOL1BASK44-ORC
M 2BSK 44 HIRON □	LIH-HOL2BASK44-LSB
Z 2BSK 44 HIRON □	LIH-HOL2BASK44-ORB
R 2BSK 44 HIRON □	LIH-HOL2BASK44-ORC

EMPIRE SKU #	LJ SKU #
M 1KNU 44 HIRON □	LIH-HOL1KNUC44-LSB
M 2KNU 44 HIRON □	LIH-HOL2KNUC44-LSB

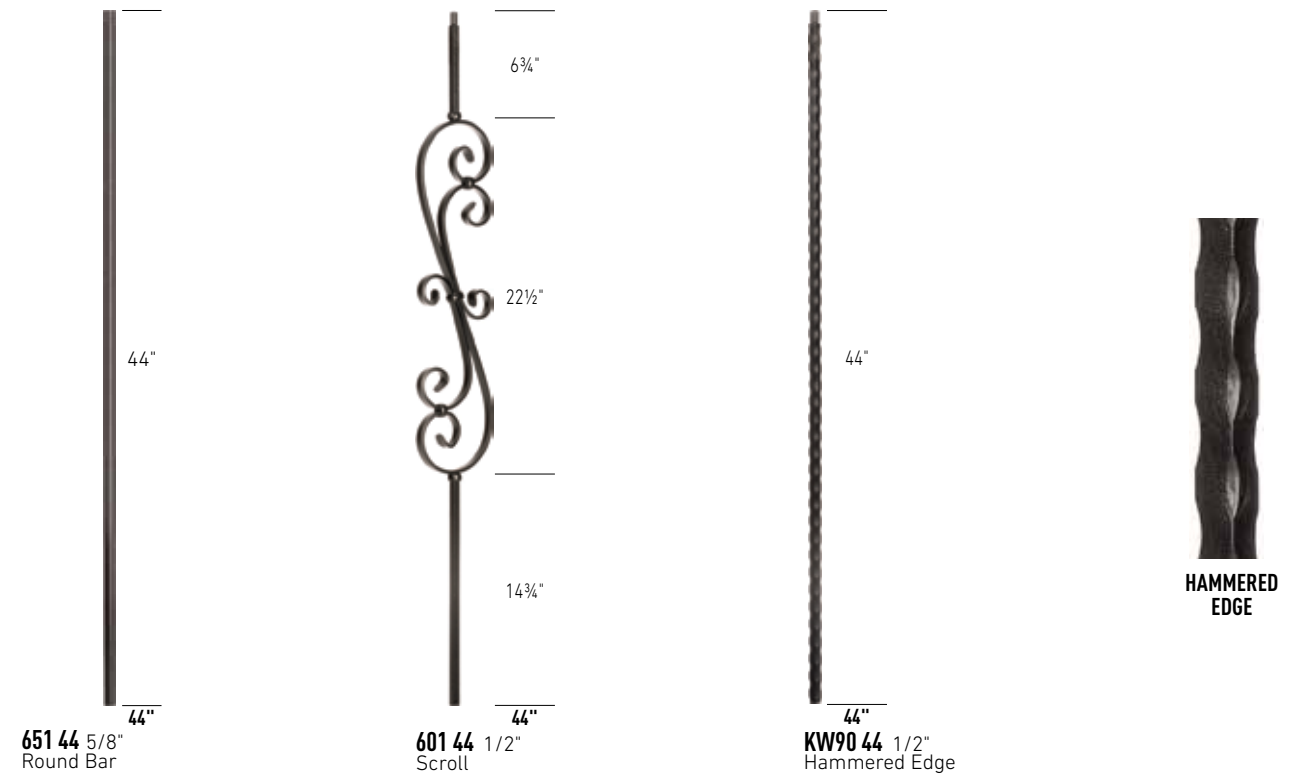

EMPIRE SKU #	LJ SKU #
M 651 44 HIRON □	LIH-HOL65144-LSB

EMPIRE SKU #	LJ SKU #
M 601 44 HIRON □	LIH-HOL60144-LSB

EMPIRE SKU #	LJ SKU #
M KW90 44 HIRON □	LIH-KW9044-LSB

HAMMERED EDGE

3/4" Mega-Width Iron Balusters

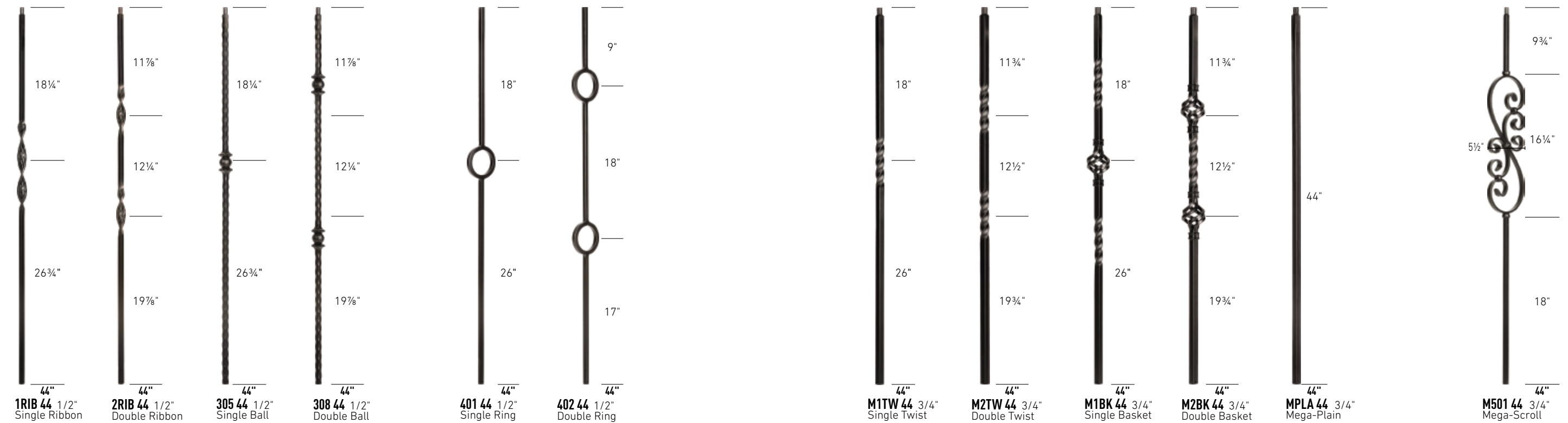

EMPIRE SKU #	LJ SKU #
M 1RIB 44 HIRON □	LIH-HOL1RIB44-LSB
M 2RIB 44 HIRON □	LIH-HOL2RIB44-LSB

EMPIRE SKU #	LJ SKU #
M 305 44 HIRON □	LIH-HOL30544-LSB
M 308 44 HIRON □	LIH-HOL30844-LSB

EMPIRE SKU #	LJ SKU #
M 401 44 HIRON □	LIH-HOL40144-LSB
M 402 44 HIRON □	LIH-HOL40244-LSB

EMPIRE SKU #	LJ SKU #
M M1TW 44 HIRON □	LIH-MG1TW44-LSB
R M1TW 44 HIRON □	LIH-MG1TW44-ORC
M M2TW 44 HIRON □	LIH-MG2TW44-LSB
R M2TW 44 HIRON □	LIH-MG2TW44-ORC

EMPIRE SKU #	LJ SKU #
M M1BK 44 HIRON □	LIH-MG1BASK44-LSB
R M1BK 44 HIRON □	LIH-MG1BASK44-ORC
M M2BK 44 HIRON □	LIH-MG2BASK44-LSB
R M2BK 44 HIRON □	LIH-MG2BASK44-ORC

EMPIRE SKU #	LJ SKU #
M MPLA 44 HIRON □	LIH-MGPLA44-LSB
R MPLA 44 HIRON □	LIH-MGPLA44-ORC

EMPIRE SKU #	LJ SKU #
M M501 44 HIRON □	LIH-MG50144-LSB
R M501 44 HIRON □	LIH-MG50144-ORC



H06 9/16"
Baluster Flat Shoe



M06 1/2"
Baluster Flat Shoe



MM08 3/4"
Baluster Flat Shoe



H05P 9/16"
Baluster Rake Shoe



PS02 1/2"
Baluster Rake Shoe



AK01 1/2"
Knuckle

MP08 3/4"
Baluster Rake Shoe



EMPIRE SKU #	LJ SKU #
3704 EPOXY	LI-3704

**3704
JOB-LOT EPOXY ADHESIVE KIT**

For securing Iron Balusters to treads, rails, landings, or kneewalls.

Job-Lot Kit includes Built-in Dispensing System, 5 oz. Adhesive Cartridge and nozzle. (Open work time is 6 minutes. Fills approximately 35 holes depending on hole size.)

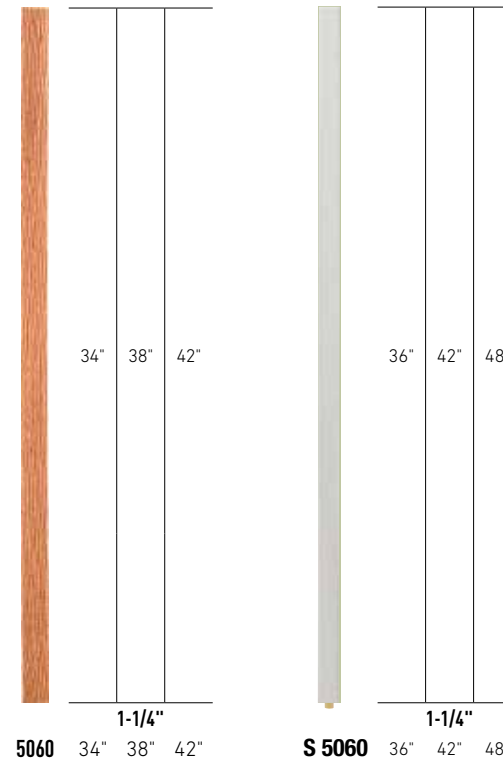

EMPIRE SKU #	LJ SKU #	(L)
5060 34 OAK	LJ-5060-O 34	34"
5060 34 POPLR	LJ-5060-P 34	
5060 34 PRIMD	LJ-5060-PRG 34	
5060 38 OAK	LJ-5060-O 38	38"
5060 38 POPLR	LJ-5060-P 38	
5060 38 PRIMD	LJ-5060-PRG 38	
5060 42 OAK	LJ-5060-O 42	42"
5060 42 WOAK	LJ-5060-WO 42	
5060 42 POPLR	LJ-5060-P 42	
5060 42 PRIMD	LJ-5060-PRG 42	
C5060 42 PRIMD	LJC-5060-PRG 42	

EMPIRE SKU #	LJ SKU #	(L)
S 5060 36 PRIMD	S-5060-PRG 36	36"
S 5060 42 PRIMD	S-5060-PRG 42	42"
S 5060 48 PRIMD	S-5060-PRG 48	48"

EMPIRE SKU #	LJ SKU #	(L)
5360 34 OAK	LJ-5360-O 34	34"
5360 34 PRIMD	LJ-5360-PRG 34	
5360 38 OAK	LJ-5360-O 38	38"
5360 38 PRIMD	LJ-5360-PRG 38	
5360 42 OAK	LJ-5360-O 42	42"
5360 42 WOAK	LJ-5360-WO 42	
5360 42 PRIMD	LJ-5360-PRG 42	

EMPIRE SKU #	LJ SKU #	(L)
S 5360 36 PRIMD	S-5360-PRG 36	36"
S 5360 42 PRIMD	S-5360-PRG 42	42"

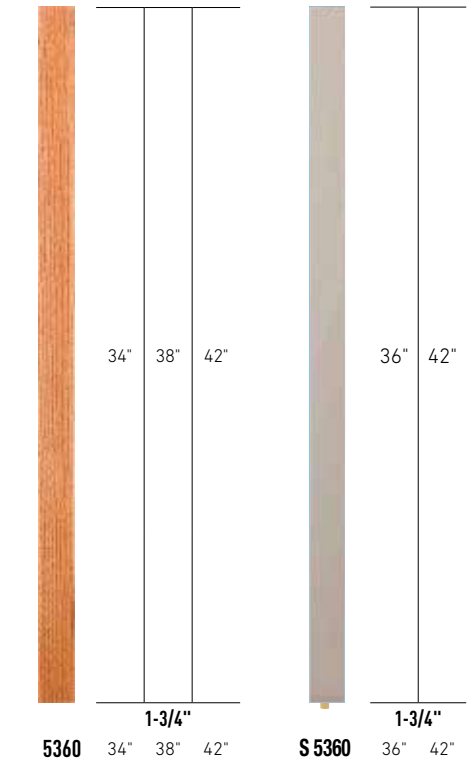

S 5060 and S 5360 balusters have a fixed pin.

EMPIRE SKU #	LJ SKU #	OPENING SIZE	DESCRIPTION
FLAT SHOE			
M H06 HIRON	LI-ALH06-LSB	9/16"	Set screw/Alum
M M06 HIRON	LI-ALM06-LSB	1/2"	Set screw/Alum
N M06 HIRON	LI-ALM06-MN		
Z M06 HIRON	LI-ALM06-ORB		
R M06 HIRON	LI-ALM06-ORC		
M MM08 HIRON	LI-ALMGM08-LSB	3/4"	Set screw/Alum
R MM08 HIRON	LI-ALMGM08-ORC		
RAKE SHOE			
M H05P HIRON	LI-ALH05P-LSB	9/16"	Set Screw/Alum
M PS02 HIRON	LI-ALPSH02-LSB	1/2"	Set Screw/Alum
N PS02 HIRON	LI-ALPSH02-MN		
Z PS02 HIRON	LI-ALPSH02-ORB		
R PS02 HIRON	LI-ALPSH02-ORC		
M MP08 HIRON	LI-ALMGPSH08-LSB	3/4"	Set Screw/Alum
R MP08 HIRON	LI-ALMGPSH08-ORC		
KNUCKLE			
M AK01 HIRON	LI-ALAK01-LSB	1/2"	Set Screw/Alum

Iron Finishes



M (LSB) = LOW SHEEN BLACK



N (MN) = MATTE NICKEL



Z (ORB) = OIL-RUBBED BRONZE



R (ORC) = OIL-RUBBED COPPER

Denoted by the letter in front of the EMPIRE SKU #

Wood Species



Red Oak (OAK)



White Oak (WOAK)



Maple (MAPLE)



Poplar (POPLR)

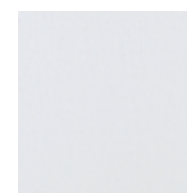

Primed (PRIMD)

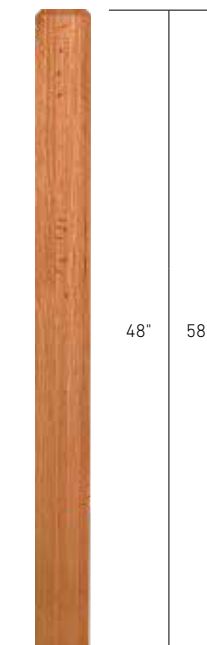

3-1/2"	
Univ. 4000	Inter. 4001
48"	58"

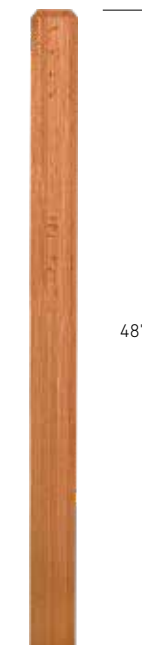

3"	
Univ. 4110	
48"	

EMPIRE SKU #	LJ SKU #	(L)
4000 OAK	LJ-4000-O	48"
4000 POPLR	LJ-4000-P	
4000 WOAK	LJ-4000-WO	
4110 OAK	LJ-4110-O	
4001 OAK	LJ-4001-O	58"
4001 POPLR	LJ-4001-P	
4001 WOAK	LJ-4001-WO	

Craftsman Newels

Square Top Wood Balusters

 Balusters come with removable pin

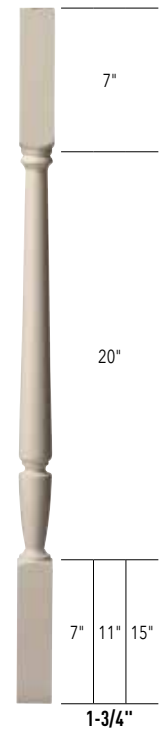

P2005 34" 38" 42"

EMPIRE SKU #	LJ SKU #	(L)
P2005 34 PRIMD	LJP-2005-PRG 34	34"
P2005 38 PRIMD	LJP-2005-PRG 38	38"
P2005 42 PRIMD	LJP-2005-PRG 42	42"



5141 34" 38" 42"

EMPIRE SKU #	LJ SKU #	(L)
5141 34 OAK	LJ-5141-O 34	34"
5141 34 PRIMD	LJ-5141-PRG 34	
5141 38 OAK	LJ-5141-O 38	38"
5141 38 PRIMD	LJ-5141-PRG 38	
5141 42 OAK	LJ-5141-O 42	42"
5141 42 PRIMD	LJ-5141-PRG 42	

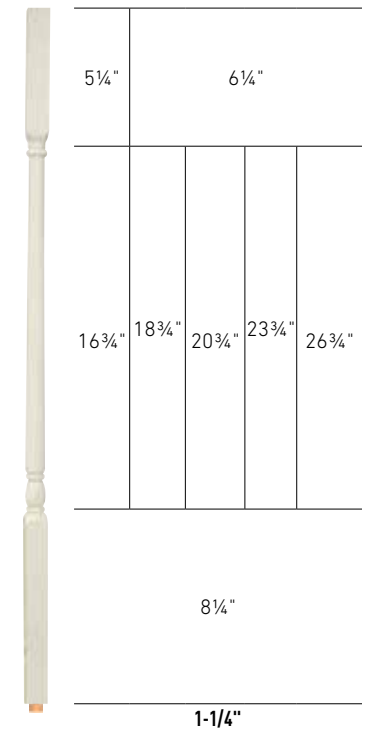

S5141 31" 34" 36" 39" 42"

EMPIRE SKU #	LJ SKU #	(L)
N 5141 31 PRIMD*	LJ-5141ND-PRG 31*	31"
S 5141 31 PRIMD	S-5141-PRG 31	
S 5141 34 PRIMD	S-5141-PRG 34	34"
S 5141 36 PRIMD	S-5141-PRG 36	36"
S 5141 39 PRIMD	S-5141-PRG 39	39"
S 5141 42 PRIMD	S-5141-PRG 42	42"

S-5141 Features a fixed bottom pin.
*N 5141 Is not pre-drilled for a pin.
EZ-PIN not included.

 Balusters come with removable pin

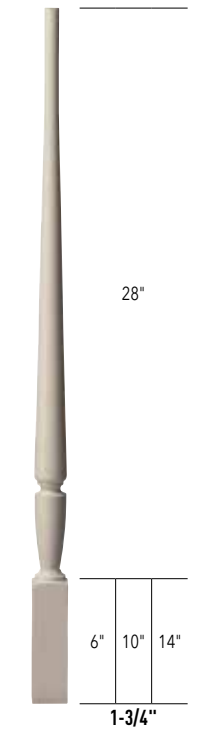

P2015 34" 38" 42"

EMPIRE SKU #	LJ SKU #	(L)
P2015 34 PRIMD	LJP-2015-PRG 34	34"
P2015 38 PRIMD	LJP-2015-PRG 38	38"
P2015 42 PRIMD	LJP-2015-PRG 42	42"

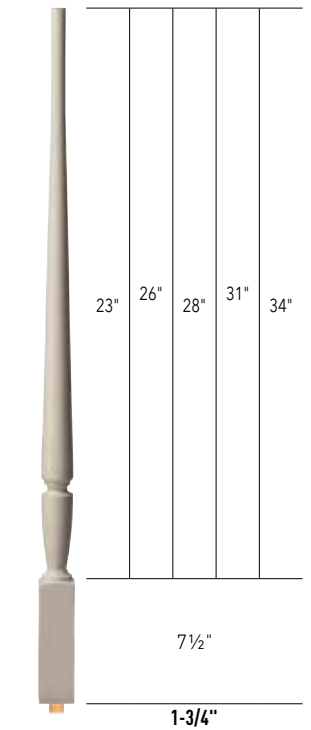

S2015 31" 34" 36" 39" 42"

EMPIRE SKU #	LJ SKU #	(L)
S 2015 31 PRIMD	SP-2015-PRG 31	31"
S 2015 34 PRIMD	SP-2015-PRG 34	34"
S 2015 36 PRIMD	SP-2015-PRG 36	36"
S 2015 39 PRIMD	SP-2015-PRG 39	39"
S 2015 42 PRIMD	SP-2015-PRG 42	42"

S-2015 Features a fixed bottom pin.

Pin Top Wood Balusters

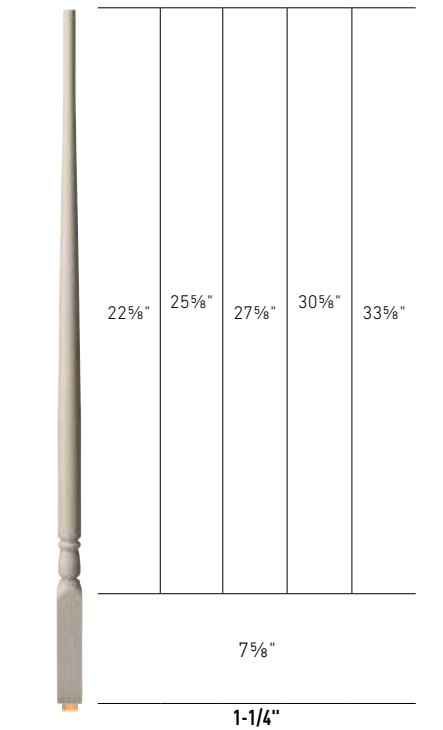

S 5015 31" 34" 36" 39" 42"

EMPIRE SKU #	LJ SKU #	(L)	EMPIRE SKU #	LJ SKU #	(L)
S 5015 31 PRIMD	S-5015-PRG 31	31"	S 5015 31 OAK	S-5015-O 31	31"
S 5015 34 PRIMD	S-5015-PRG 34	34"	S 5015 34 OAK	S-5015-O 34	34"
S 5015 36 PRIMD	S-5015-PRG 36	36"	S 5015 36 OAK	S-5015-O 36	36"
S 5015 39 PRIMD	S-5015-PRG 39	39"	S 5015 39 OAK	S-5015-O 39	39"
S 5015 42 PRIMD	S-5015-PRG 42	42"	S 5015 42 OAK	S-5015-O 42	42"

S-5015 Features a fixed bottom pin.



5067 34" 38" 42"

EMPIRE SKU #	LJ SKU #	(L)
5067 34 OAK	LJ-5067-O 34	34"
5067 34 PRIMD	LJ-5067-PRG 34	
5067 38 OAK	LJ-5067-O 38	38"
5067 38 PRIMD	LJ-5067-PRG 38	
5067 42 OAK	LJ-5067-O 42	42"
5067 42 PRIMD	LJ-5067-PRG 42	



5005 34" 38" 42"

EMPIRE SKU #	LJ SKU #	(L)
5005 34 OAK	LJ-5005-O 34	34"
5005 34 PRIMD	LJ-5005-PRG 34	
5005 38 OAK	LJ-5005-O 38	38"
5005 38 PRIMD	LJ-5005-PRG 38	
5005 42 OAK	LJ-5005-O 42	42"
5005 42 PRIMD	LJ-5005-PRG 42	



5200 34" 38" 42"

EMPIRE SKU #	LJ SKU #	(L)
5200 34 PRIMD	LJ-5200-PRG 34	34"
5200 38 PRIMD	LJ-5200-PRG 38	38"
5200 42 PRIMD	LJ-5200-PRG 42	42"



5300 34" 38" 42"

EMPIRE SKU #	LJ SKU #	(L)
5300 34 PRIMD	LJ-5300-PRG 34	34"
5300 38 PRIMD	LJ-5300-PRG 38	38"
5300 42 PRIMD	LJ-5300-PRG 42	42"



S 5300 31" 34" 36" 39" 42"

EMPIRE SKU #	LJ SKU #	(L)
S 5300 31 PRIMD	S-5300-PRG 31	31"
S 5300 34 PRIMD	S-5300-PRG 34	34"
S 5300 36 PRIMD	S-5300-PRG 36	36"
S 5300 39 PRIMD	S-5300-PRG 39	39"
S 5300 42 PRIMD	S-5300-PRG 42	42"

S-5300 Features a fixed bottom pin.



5015 34" 38" 42"

EMPIRE SKU #	LJ SKU #	(L)
5015 34 OAK	LJ-5015-O 34	34"
5015 34 PRIMD	LJ-5015-PRG 34	
5015 38 OAK	LJ-5015-O 38	38"
5015 38 PRIMD	LJ-5015-PRG 38	
5015 42 OAK	LJ-5015-O 42	42"
5015 42 PRIMD	LJ-5015-PRG 42	

Over the Post Newels

Post to Post Newels

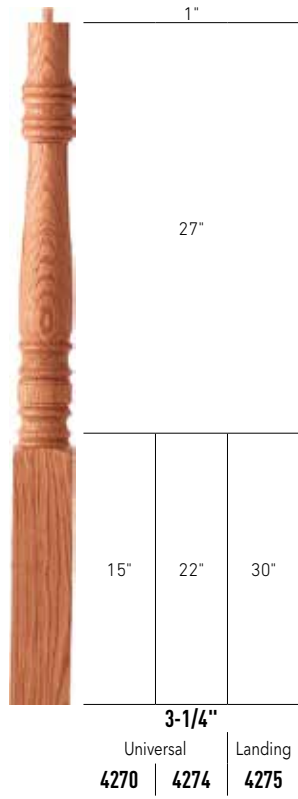

EMPIRE SKU #	LJ SKU #	(L)
4270 OAK	LJ-4270-0	43"
4274 OAK	LJ-4274-0	50"
4275 OAK	LJ-4275-0	58"

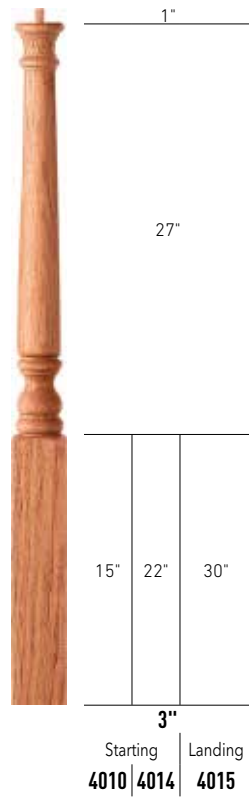

EMPIRE SKU #	LJ SKU #	(L)
4010 OAK	LJ-4010-0	43"
4013 PT OAK	LJ-4013PT-0	50"
4014 OAK	LJ-4014-0	50"
4015 OAK	LJ-4015-0	58"



EMPIRE SKU #	LJ SKU #	(L)
4013 PT OAK	LJ-4013PT-0	50"
4014 OAK	LJ-4014-0	50"
4015 OAK	LJ-4015-0	58"

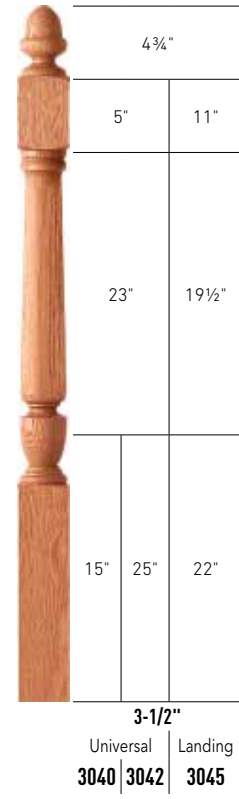

EMPIRE SKU #	LJ SKU #	(L)
P3040 OAK	LJP-3040-0	48"
P3042 OAK	LJP-3042-0	58"
P3045 OAK	LJP-3045-0	



EMPIRE SKU #	LJ SKU #	(L)
4180 OAK	LJ-4180-0	48"
4182 OAK	LJ-4182-0	58"
4185 OAK	LJ-4185-0	
4186 OAK	LJ-4186-0	73"



EMPIRE SKU #	LJ SKU #	(L)
4180 OAK	LJ-4180-0	48"
4182 OAK	LJ-4182-0	58"
4185 OAK	LJ-4185-0	
4186 OAK	LJ-4186-0	73"

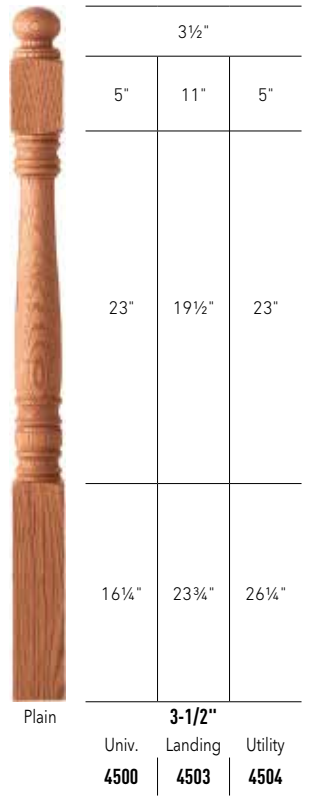

EMPIRE SKU #	LJ SKU #	(L)
4500 OAK	LJ-4500-0	48"
4503 OAK	LJ-4503-0	58"
4504 OAK	LJ-4504-0	



Achieve a similar look using: 6519 Rail | 3010/3014 Newel | 601 44 / 140 44 / 150 44 Balusters | PS02/ M06 Shoes

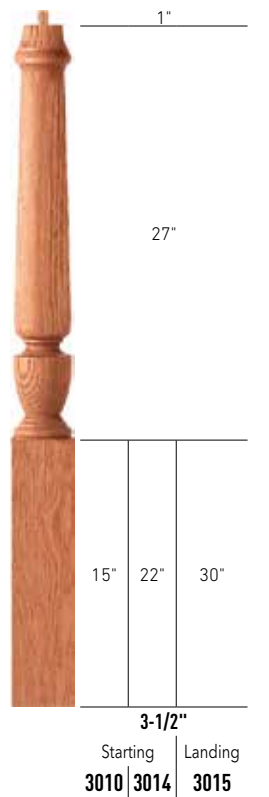

EMPIRE SKU #	LJ SKU #	(L)
P3010 OAK	LJP-3010-0	43"
P3014 OAK	LJP-3014-0	50"
P3015 OAK	LJP-3015-0	58"

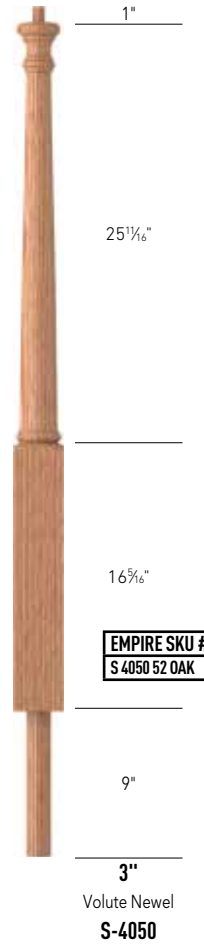

EMPIRE SKU #	LJ SKU #	(L)
S 4050 52 OAK	S-4040PB-52-0	52"

Volute Newel
S-4050



EMPIRE SKU #	LJ SKU #	(L)
4040 OAK	LJ-4040-0	48"
B 4040 OAK	LJ-4040BT-0	
4040 POPLR	LJ-4040-P	
4042 OAK	LJ-4042-0	58"
B 4042 OAK	LJ-4042BT-0	
4042 POPLR	LJ-4042-P	
4042 WOAK	LJ-4042-WO	
4045 OAK	LJ-4045-0	58"
B 4045 OAK	LJ-4045BT-0	
4045 POPLR	LJ-4045-P	
4045 WOAK	LJ-4045-WO	
4046 OAK	LJ-4046-0	73"
B 4046 OAK	LJ-4046BT-0	



4040 series OAK Newels also available in a Ball Top (BT)



EMPIRE SKU #	LJ SKU #	(L)
4040 OAK	LJ-4040-0	48"
B 4040 OAK	LJ-4040BT-0	
4040 POPLR	LJ-4040-P	
4042 OAK	LJ-4042-0	58"
B 4042 OAK	LJ-4042BT-0	
4042 POPLR	LJ-4042-P	
4042 WOAK	LJ-4042-WO	
4045 OAK	LJ-4045-0	58"
B 4045 OAK	LJ-4045BT-0	
4045 POPLR	LJ-4045-P	
4045 WOAK	LJ-4045-WO	
4046 OAK	LJ-4046-0	73"
B 4046 OAK	LJ-4046BT-0	



Achieve a similar look using: 6010 Rail | 4040/4042 Newel | 1 KNU / 2 KNU Balusters | PS02 / M06 Shoes

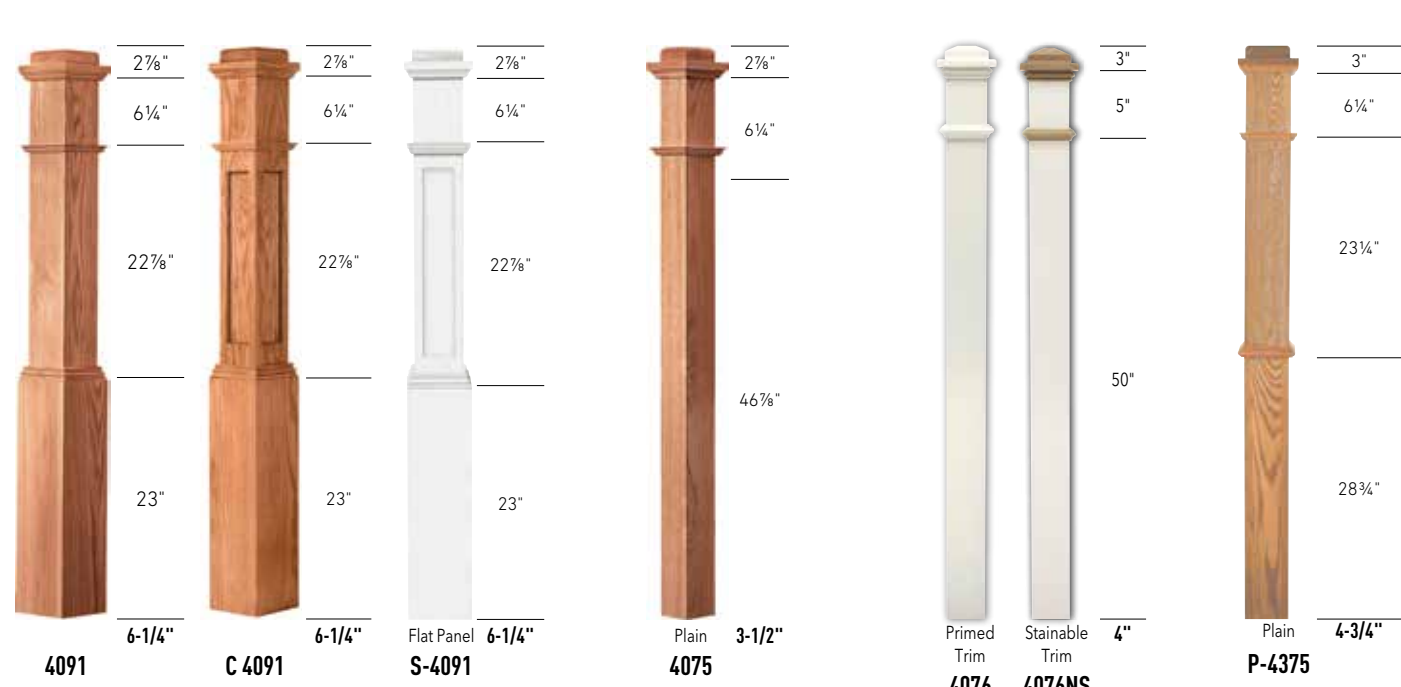

EMPIRE SKU #	LJ SKU #	(L)
4091 MAPLE	LJ-4091-M	55"
4091 OAK	LJ-4091-O	
4091 POPLR	LJ-4091-P	
4091 PRIMD	LJ-4091-PRG	
4091 WOAK	LJ-4091-WO	
C 4091 OAK	LJRC-4091-O	
C 4091 PRIMD	LJRC-4091-PRG	
S 4091 PRIMD	LJSK-4091-PRG	

EMPIRE SKU #	LJ SKU #	(L)
4075 MAPLE	LJ-4075-M	56"
4075 OAK	LJ-4075-O	
4075 POPLR	LJ-4075-P	
4075 PRIMD	LJ-4075-PRG	
4075 WOAK	LJ-4075-WO	

EMPIRE SKU #	LJ SKU #	(L)
4076 PRIMD	LJ-4076-PRG	58"
4076 NS PRIMD	LJ-4076NS-PRG	

EMPIRE SKU #	LJ SKU #	(L)
P 4375 OAK	LJP-4375-O	61-1/2"

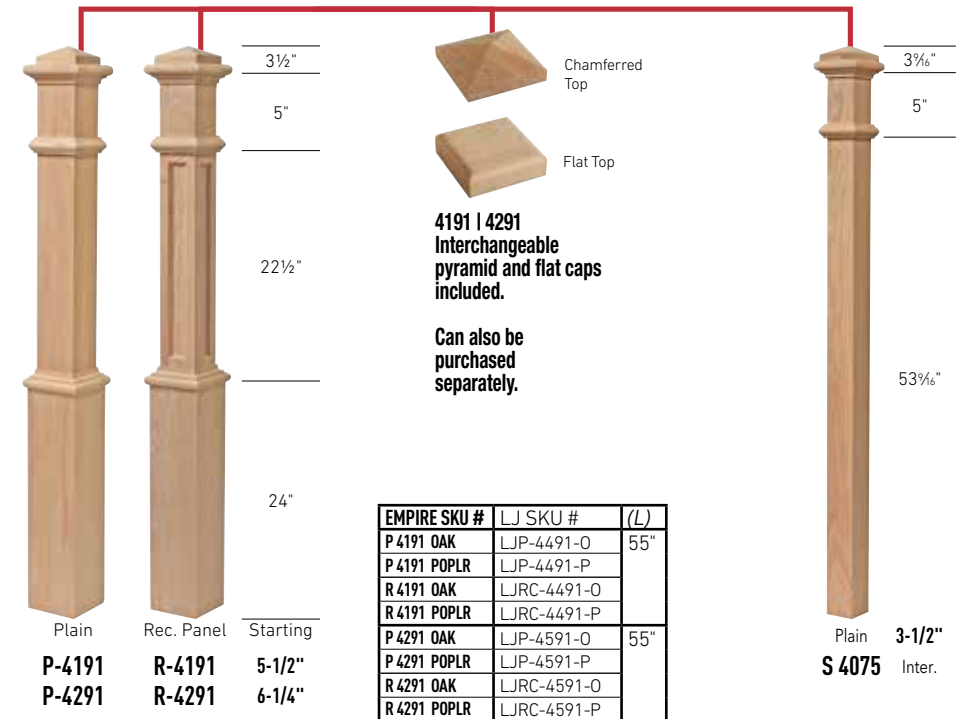

EMPIRE SKU #	LJ SKU #	(L)
P 4191 OAK	LJP-4491-O	55"
P 4191 POPLR	LJP-4491-P	
R 4191 OAK	LJRC-4491-O	
R 4191 POPLR	LJRC-4491-P	
P 4291 OAK	LJP-4591-O	55"
P 4291 POPLR	LJP-4591-P	
R 4291 OAK	LJRC-4591-O	
R 4291 POPLR	LJRC-4591-P	

EMPIRE SKU #	LJ SKU #	(L)
S 4075 OAK	S-4075-O	63-3/4"
S 4075 POPLR	S-4075-P	

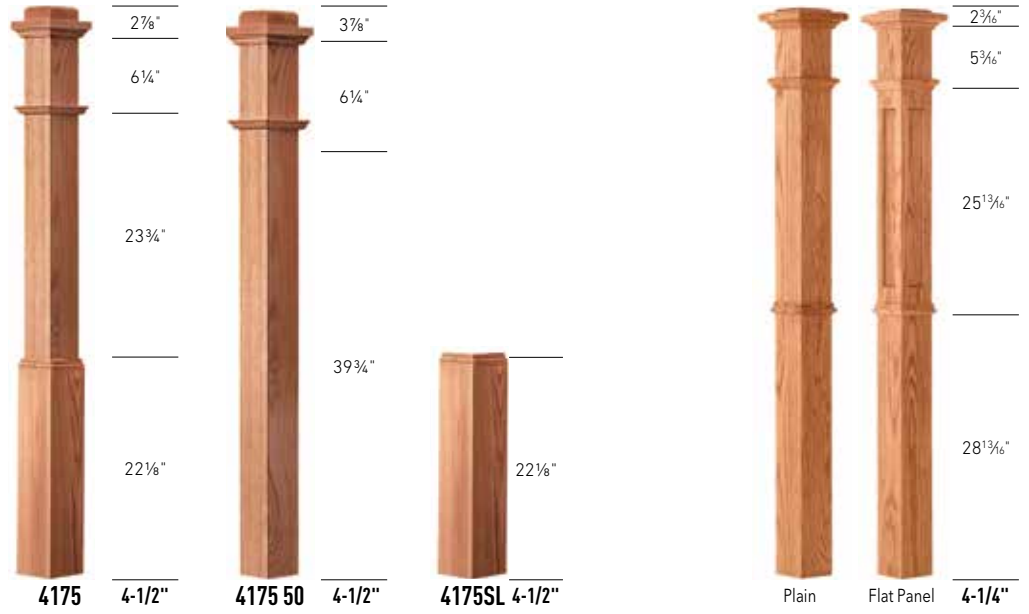

EMPIRE SKU #	LJ SKU #	(L)
4175 OAK	LJ-4175-O	56"
4175 50 OAK	LJ-4175-50-O	50"

EMPIRE SKU #	LJ SKU #	(L)
4175 SL MAPLE	LJ-4175SL-M	22-1/8"
4175 SL OAK	LJ-4175SL-O	
4175 SL POPLR	LJ-4175SL-P	
4175 SL WOAK	LJ-4175SL-WO	
4175 SL PRIMD	LJ-4175SL-PRG	

EMPIRE SKU #	LJ SKU #	(L)
4392 OAK	LJ-4392-O	62"
4394 OAK	LJ-4394-O	

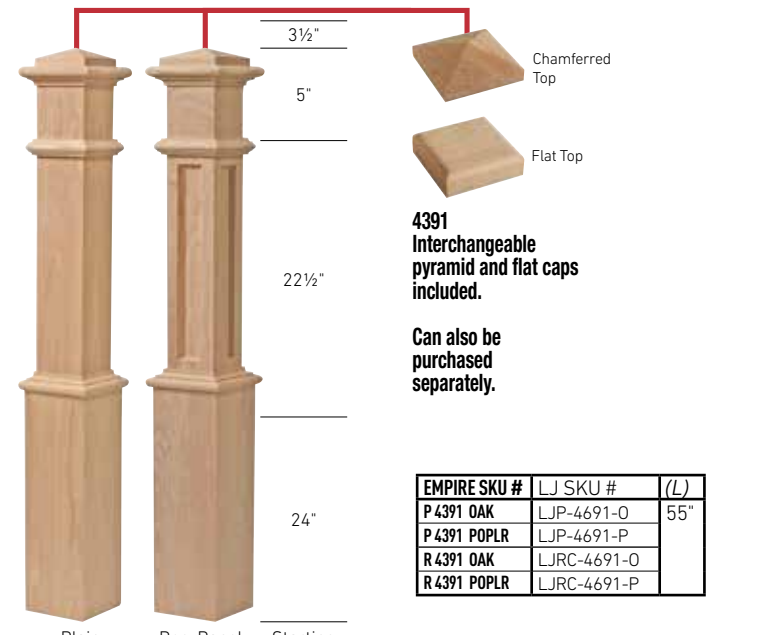

EMPIRE SKU #	LJ SKU #	(L)
P 4391 OAK	LJP-4691-O	55"
P 4391 POPLR	LJP-4691-P	
R 4391 OAK	LJRC-4691-O	
R 4391 POPLR	LJRC-4691-P	

Achieve a similar look using: **6010** Rail | **R4191** Box Newel
PLA 4 Balusters w **AK01** Knuckles | **PS02** Shoes



Newel/Rail Installation Hardware

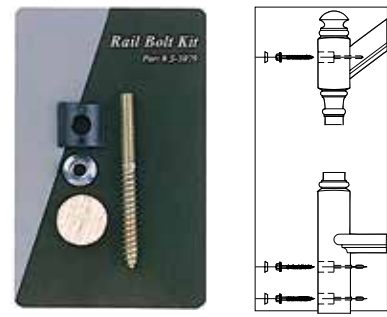

3001 / 3079
RAIL BOLT



3078
RAIL / POST FASTENER

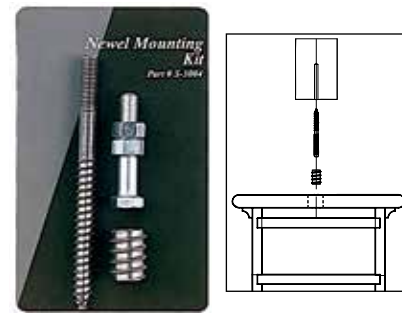

3004
NEWEL MOUNTING KIT



3000
1" TAPERED PLUG

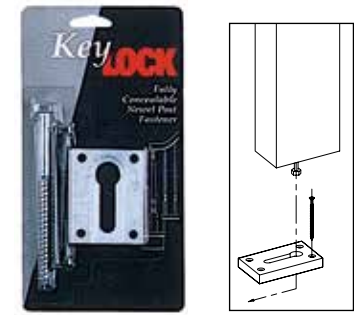

3005
KEYLOCK™ NEWEL MOUNTING FASTENER

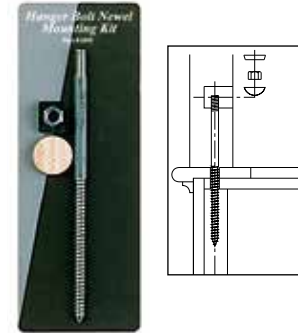

3008-10
NEWEL POST FASTENER
10-3/4"

EMPIRE SKU #	LJ SKU #	DESCRIPTION
3000 OAK	LJ-3000-0	Tapered Plug 1" Oak
3001 OAK	LJ-3001	Rail Bolt (No Plug)
3004 OAK	LJ-3004	Newel Mounting Kit
3005 OAK	LJ-3005	Keylock Fastener
3006 OAK	LJ-3006-0	Newel Mounting Plate / Oak Trim
3006 PL OAK	LJ-3006-PLATE	Newel Mounting Plate Only
3008 10 OAKPP	LJ-3008-10-0/P	Newel Fastener Oak/Poplar Plug
3009 OAK	LJ-3009-0	Angle Bracket Post Fastener - 3" Oak Trim
3019 OAK	LJ-3019-0	Angle Bracket Post Fastener - 3-1/2" Oak Trim
3076 OAK	LJ-3076	Baluster Dowel Fast Screws 50 Pack
3078 OAKPP	LJ-3078-0/P	Rail/Post Fastener / Oak/Poplar Plug
3079 OAKPP	LJ-3079-0/P	Rail Bolt Kit / Oak/Poplar Plug
FAST OAK	LJ-FAST	Newel Installation Kit

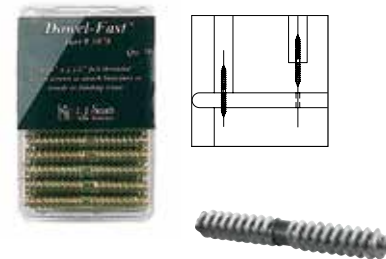

3076
BALUSTER DOWEL FAST SCREWS
50 pack

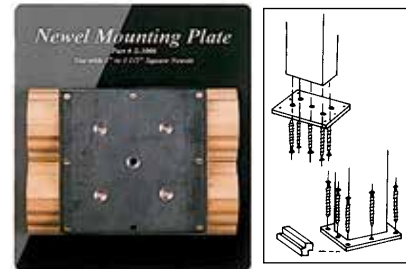

3006
NEWEL MOUNTING KIT W/PLATE
3006 PL
PLATE ONLY

Fas-n-Fast™

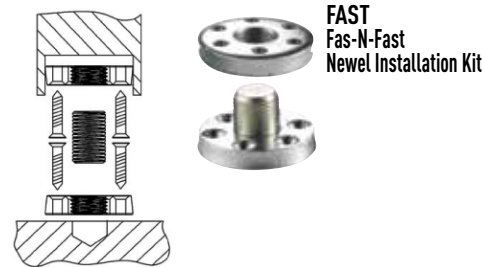

FAST
Fas-N-Fast
Newel Installation Kit



3009 - 3" Angle Bracket Post Fastener Kit
3019 - 3-1/2" Angle Bracket Post Fastener Kit
ANGLE BRACKET POST FASTENER

ZipBolt™ Rail Installation Hardware



EMPIRE SKU #	LJ SKU #
3001 DG OAK	ZIPBOLT DRILL GUIDE
3001 DR OAK	ZIPBOLT DRIVER
3001 SF OAK	ZIPBOLT SLIPFIX 2-0 (2-PACK)
3001 SP OAK	ZIPBOLT RAILBOLT
2 3001 SP OAK	ZIPBOLT RAILBOLT 2-0 (2-PACK)
A 3001 OAK	ZIPBOLT ANGLED
A 3001-2 OAK	ZIPBOLT ANGLED 2-0 (2-PACK)



A3001 — Single
A3001-2 — 2-Pack
RAKE INSTALLATION
ANGLED ZIPBOLT™

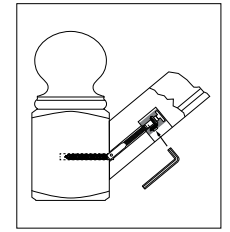

3001SP
2 3001 SP
ZIPBOLT™ — 2-Pack

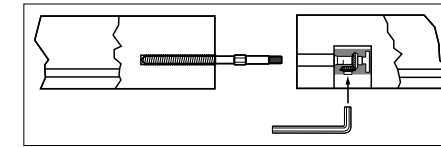

3001SF — 2 Pack
BALCONY INSTALLATION
SLIPFIX ZIPBOLT™

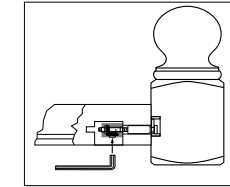

3001DG
ZIPBOLT™ DRILL GUIDE
KIT



3001DR
ZIPBOLT™ DRIVER

Wall Rail Brackets



3012
Wall Rail
Mounting Bracket

EMPIRE SKU #	LJ SKU #	DESCRIPTION
3012 AN SIRON	LJ-3012-AN	Wall Bracket Ant. Nickel
3012 BB SIRON	LJ-3012-BB	Wall Bracket Bright Brass
3012 BM SIRON	LJ-3012-BM	Wall Bracket Black Matte
3012 BZ SIRON	LJ-3012-BZ	Wall Bracket Bronze
3012 PC SIRON	LJ-3012-PC	Wall Bracket Pol Chrome
3012 SN SIRON	LJ-3012-SN	Wall Bracket Satin Nickel



3127
Wall Solid Rail
Mounting Bracket
Screws included.

EMPIRE SKU #	LJ SKU #	DESCRIPTION
3127 BB SIRON	LJ-3127-BB	Wall Bracket Bright Brass
3127 BM SIRON	LJ-3127-BM	Wall Bracket Black Matte
3127 BZ SIRON	LJ-3127-BZ	Wall Bracket Oil Rub Bronze
3127 PC SIRON	LJ-3127-PC	Wall Bracket Polished Chrome
3127 SN SIRON	LJ-3127-SN	Wall Bracket Satin Nickel



Turncraft Columns & Porch Post

In-Stock and available for Quick Ship (Call and Check availability).
 More styles and innovative Turncraft products available for special order at:
TURNCRAFT.COM

Round Poly Classic Columns (Cast FRP)

6 2742 TURNC	Tapered Column	8" x 8'
2 4244 TURNC		8" x 9'
6 2743 TURNC		8" x 10'
6 2744 TURNC		10" x 8'
2 4245 TURNC		10" x 9'
6 2745 TURNC		10" x 10'
6 2747 TURNC		12" x 8'
6 2748 TURNC		12" x 10'
7 6163 TURNC		Round Time Saver Cap & Base Set "install kit included"
7 6164 TURNC		10"
7 1740 TURNC		12"
2 5063 TURNC	Foam Cap & Base Set Round	8"
2 5064 TURNC		10"
2 5065 TURNC		12"

Round Wood Tapered Columns

P 1088 TURNC	Tapered Column	8" x 8'
0810 TURNC		8" x 10'
1108 TURNC		10" x 8'
1110 TURNC		10" x 10'
F 1088 TURNC	Fluted Column	8" x 8'
7 2262 TURNC	Cap & Base Set for Wood Columns	8"
2510 TURNC		10"

Split Round Poly Classic Columns (Cast FRP)

6 2928 X TURNC	Split Tapered Column	8" x 8'
6 2929 X TURNC		8" x 10'
6 2930 X TURNC		10" x 8'
6 2931 X TURNC		10" x 10'
7 6163 TURNC		EZ Lock Split Cap & Base Set
7 6164 TURNC		10"
7 2665 TURNC	SPLIT Column Installation Kit	

Installation Kit for Poly Classic Columns

7 1760 TURNC	Poly Classic Installation Kt	Timesaver C&B Sets include Installation kit. Separate with other C&B options
--------------	------------------------------	--

Timesaver Cap & Base

Turncraft's Timesaver Cap & Base offers the easiest and quickest installation in the industry



- Made out of fiber-reinforced recycled ABS (acrylonitrile butadiene styrene)
- Designed for use on round FRP columns in 8", 10", and 12" sizes
- Made with 95% recycled material
- Extremely strong and durable
- Self aligning with no fasteners
- Excellent paint adhesion
- Fast installation

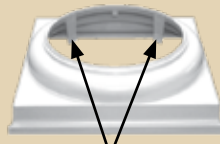

Pressure Tabs



NEW Pro Series Square Columns (Cast FRP)

The New Square Pro-Series FRP Columns are lighter and cost less with the same load bearing capacities

- 5-14% price reduction over the standard square column
- 8-12% lighter weight than standard square FRP column
- Adjustable/removable neck mold on 8", 10" and 12" columns

7 2814 TURNC	Square Non-Tapered Column	6" x 6" x 8'
7 2815 TURNC		6" x 6" x 10'
0 9316 TURNC		8" x 8" x 8'
0 9318 TURNC		8" x 8" x 10'
7 1000 TURNC		10" x 10" x 8'
7 1002 TURNC		10" x 10" x 10'
7 1006 TURNC		12" x 12" x 10'
7 1007 TURNC		12" x 12" x 12'
7 3816 TURNC	Tuscan Cap & Base Set TimeSaver	8"
7 1110 TURNC		10"
7 3329 TURNC	Tuscan Cap & Base Set FOAM	6"
7 3849 TURNC		8"
7 3850 TURNC		10"
0 9350 TURNC		12"

Duraglass Square Columns (Pultruded)

- Adjustable/removable neck mold on 8", 10" and 12" columns

7 3819 TURNC	Square Non-Tapered Column	8" x 8" x 8'
7 3821 TURNC		8" x 8" x 10'
7 3824 TURNC		10" x 10" x 8'
7 3826 TURNC		10" x 10" x 10'
0 9336 TURNC		12" x 12" x 12'
7 3816 TURNC	Tuscan Cap & Base Set TimeSaver	8"
7 1110 TURNC		10"
7 3849 TURNC	Tuscan Cap & Base Set FOAM	8"
7 3850 TURNC		10"
0 9350 TURNC		12"



Turncraft Columns



Wood Porch Post

D 3049 A TURNC	Post Defense W/Acrylic Prmr	4" x 9"
D 3059 A TURNC	Post Defense W/Acrylic Prmr	5" x 9"
D 3059 A TURNC	Post Defense W/Acrylic Prmr	5" x 9"
1 7004 UNVSL	Porch Post Fastener	4"
1 7005 UNVSL	Porch Post Fastener	5"
1 7006 UNVSL	Porch Post Fastener	6"

*Post Saver™ Mount Block required for warranty on wood porch post.



Duraglass Bungalow Square Tapered (Pultruded)

0 9479 TURNC	Tapered Square Column	12" x 8" x 5'
0 9480 TURNC		12" x 8" x 6'
0 9482 TURNC		16" x 12" x 5'
0 9483 TURNC		16" x 12" x 6'
0 9520 TURNC	Bungalow Tuscan Square Cap & Base	12"
0 9521 TURNC		16"

Moulding Index

Pattern	Pg #	Pattern	Pg #	Pattern	Pg #	Pattern	Pg #	Pattern	Pg #
2	48	B G212	30	L 432	32	865	46	1899	44
37	31	230	49	432	32	B 871	34	4520	30
041	42	231	49	L 433	36	876	46	5010	33
043	43	L 232	49	L 433E	36	L 878	46	5021	33
L 45	42	L 233	49	444	32	886	46	5030	33
N 45	42	239	48	444A	31	L 887	46	7055	38
L 46	41	240	49	L 445 (99)	32	B 887	34	7163	39
L 47	41	L 247	48	445	31	887	46	8412	36
F 49	40	L 249	48	445A	31	L 888	46	8416	36
L 49	40	B G250	47	L 452	30	888	46	8578	47
52	40	L 254	48	452	30	B 892	35	9243	38
53	40	254	48	458	45	B 895	35	9750	36
68	40	263	39	472	30	912	36	1X6 EC	49
75	40	5 263	48	L 473	30	B 915	34	B GC1	36
84	40	W 266	48	505	43	925	46	B GC2	36
86	40	L 266	48	EC512	42	L 936	46	L CAP	47, 49
93	48	L 267	48	B G512	38	936	46	L CC14	31
99 (L 445)	32	L 268	48	512	38	946	46	CR291	41
B G100	48	280	47	512E	38	947	46	DC97	32
B100	32	281	47	L 514	38	951	46	MDC97	32
100	48	292	47	W B514	38	L 956W	47	L BRB3	30
103	48	297	47	E 519	41	956W	47	LK4	32
105	48	300	47	520	48	956	46	PT3	31
106	48	304H	31	530	42	958	46	S RB3	32
108	48	B 312	37	535	31	L 983	46	RB3	32
122	48	B G312	31	545	37	984	46	SA612	33
126	48	W C312	31	618	37	995	48	SCBA	39
129	48	312	31	620	37	1006	32	5 SCBA	38
131	48	315	30	623	36	1021	45	SCCA	31
133	44	327	30	633	36	4 1021	45	SL16	49
142	48	W 331	32	L 634	36	6 1021	45	SL18	49
144	48	331	30	B 642	34	7 1021	45	STBA	39
163	36	334	34	660	37	E 1035	48	5 STBA	38
L 163	36	L 340	40	662	37	1075	48	STCA	31
L 163E	37	351	30	663	36	1163	45	L WCAP	47
163E	37	L 356	30	682	31	1195	45	See page 22-26 for Decorative Accessories offerings.	
L 167	36	356	30	685	31	S 1196	45	See page 28 for Board offerings.	
180	44	358	45	B G712	39	B 1200	34	See page 27 for Flexible Moulding .	
183	47	L 361	32	713	36	1219	47	See page 29 for Jams offerings.	
L 184	47	361	30	721	43	1305	44	See page 35 for Corbel offerings.	
184	40	366	30	730	43	1400	34	See page 68-69 for Columns offerings.	
185	41	366A	30	B 734	34	1401	34		
B G200	47	376	30	738	37	1402	34		
L 201	42	L 390	47	B 740	34	1403	34		
202	48	390	47	B 742	34	1889	44		
204	48	400	40	B 743	34	1892	35		
205	48	L 412	32	750	37	1895	35		
206	48	E 412	32	750W	38	1888	44		
207	39	412	32	753	36	1897	44		
L 210	44	L 414	37	857	46	1898	44		

Stair Parts Index

Rails, Fittings, Treads		Rails, Fittings, Treads		Wood Balusters		Wood Newels		Hardware	
Item No.	Pg #	Item No.	Pg #	Item No.	Pg #	Item No.	Pg #	Item No.	Pg #
684	52	7099	53	P2005	60	P3010	62	3000	66
P6000	52	8010-2	53	P2015	61	P3014	62	A 3001	67
S6000	52	8079	53	S 2015	61	P3015	62	A 3001-2	67
6000	52	8080 13	53	5005	60	P3040	63	3001	66
P6001	52	5 8090	53	S 5015	61	P3042	63	3001 DG	67
S6001	52	8090	53	5015	61	P3045	63	3001 DR	67
6002	52	EZ-Pin	53	S 5060	59	4000	59	3001 SF	67
6007	52	Treads	54	5060	59	4001	59	3001 SP	67
6040	52	Risers	54	5067	60	4010	62	2 3001 SP	67
6042	52	Starting Step	54	N 5141	60	4013 PT	62	3004	66
6050	52			S 5141	60	4014	62	3005	66
B6010	52			5141	60	4015	62	3006	66
6010 / P6010	52			5200	61	4040	63	3006 PL	66
1 6210	52			S 5300	61	4042	63	3008 10	66
6210 / P 6210	52			5300	61	4045	63	3009	66
P6045	52			S 5360	59	4046	63	3012	67
6400	52			5360	59	S 4050	62	3019	66
6519 / P6516	52					4075	64	3076	66
7009	53					S 4075	65	3078	66
7010	53					4076	64	3079	66
7011 / 7211	53					C4091	64	3127	67
7012 / 7212	53					S4091	64	FAST	66
7013	53					4091	64		
7014 / 7214	53					4110	59		
7019	53					4175	64		
7020	53					4175 SL	64		
7021	53					4180	63		
7021 13	53					4182	63		
7023	53					4185	63		
7026	53					4186	63		
7027	53					P 4191	65		
7028	53					4270	62		
7029	53					4274	62		
7030	53					4275	62		
7033	53					P 4291	65		
7035	53					P 4375	64		
7037	53					P 4391	65		
7040	53					4392	64		
7045	53					4394	64		
7047	53					4500	63		
7048	53					4503	63		
7060 / 7065	53					4504	63		
7081 / 7086	53								
7088-2	53								



EMPIRECO.COM

Explore our comprehensive collections of mouldings, stair parts, boards, and exterior millwork as well as find inspiration for every room in the home.



Northeast Distribution Center

Allentown Commerce Park Building 1
2027-35 S. 12th Street | Allentown, PA 18103

Email: n1salesorders@empireco.com

P: 800.253.9000 | F: 800.772.5574

© 2020 EMPIRE CO. N1(Rev.06/20)

Empire reserves the right to make changes to the products listed in this catalog without notice and without responsibility for existing units. Drawings may not be to exact scale.